



159 N. ACACIA STREET * SAN DIMAS, CA 91773
PHONE: (909) 599-9606 * FAX: (909) 599-6238

CAMARILLO, CA 93010 * PHONE: (805) 482-1215
www.genpump.com

WELL & PUMP SERVICE SINCE 1952

Serving Southern California and Central Coast

Lic. #496765

Request for Bid

RIO MESA HIGH SCHOOL WELL #2 REHABILITATION

BID #654

December 15, 2021 @ 10:00 am

Prepared by

Luis Busso

General Pump Company, Inc.

For The

OXNARD UNION HIGH SCHOOL DISTRICT

309 S K St
Oxnard, CA 93030



BID #654

**RIO MESA HIGH SCHOOL WELL #2
REHABILITATION**

OXNARD UNION HIGH SCHOOL DISTRICT

Bids due electronically by

December 15, 2021 @ 3:00 p.m.

to

Deanna.Rantz@oxnardunion.org

**Bid 654
Rio Mesa High School Well No.2
Rehabilitation
RMHS**

**OXNARD UNION HSD
DIVISION ZERO-1**



159 N. ACACIA STREET * SAN DIMAS, CA 91773
PHONE: (909) 599-9606 * FAX: (909) 599-6238

CAMARILLO, CA 93010 * PHONE: (805) 482-1215
www.genpump.com

WELL & PUMP SERVICE SINCE 1952

Lic. #496765

Serving Southern California and Central Coast

December 15, 2021

Via Email

Oxnard Union High School District
Bid #654
Rio Mesa High School Well No. 2 Rehabilitation

Subject: RMHS Well No. 2 Rehab – Steel Material Pricing

General Pump Company strives to always provide our clients the best possible engineering, workmanship, materials, and cost for the specific well and/or pump application. All equipment designs and materials of construction are based on our best interpretation of the specification provided by OUHSD.

It has become necessary to provide this cautionary notice that pricing included in this bid reflect the current material costs in the industry which have been unstable recently given the pandemic and global supply chain issues the world is experiencing. Depending on the time to award and confirm material costs, it may be necessary to update material pricing and adjust for changing conditions. If required to change pricing, General Pump Company will be transparent in providing documentation for any adjustments that may stem from pricing fluctuations.

Should you have any questions or need additional information regarding the above summary and associated cost, please do not hesitate to contact us. Thank you for the opportunity to provide a bid on this project and we look forward to working with you.

GENERAL PUMP COMPANY, INC.

Luis Busso, P.G.

Luis Busso
Senior Project Geologist

EXHIBIT A
CONTRACTOR BID TABULATION SHEET

| SPECIFICATION SECTION NO. | BID ITEM NO. | WORK TASK | UNIT | AMOUNT | COST PER BID UNIT | TOTAL BID ITEM COST |
|---------------------------|--------------|---|------|--------|-------------------|---------------------|
| 10 | 1 | MOBILIZATION/DEMOBILIZATION | LS | 1 | \$71,133.95 | \$71,133.95 |
| 11 | 2 | PUMP REMOVAL AND INSPECTION | LS | 1 | \$7,320 | \$7,320 |
| 12 | 3 | VIDEO SURVEY | EA | 2 | \$2,273 | \$4,546 |
| 13 | 4 | CALIPER SURVEY | LS | 1 | \$5,000 | \$5,000 |
| 14 | 5 | GRAVEL BACKFILL AND BENTONITE SEAL | LS | 1 | \$10,213 | \$10,213 |
| 15 | 6 | CASING 8-INCH STAINLESS STEEL (0.25 WALL) | LF | 198 | \$277 | \$54,749 |
| 15 | 7 | 8X6-INCH REDUCER STAINLESS STEEL | LS | 1 | \$1,286 | \$1,286 |
| 15 | 8 | CASING 6-INCH STAINLESS STEEL (0.25 WALL) | LF | 152 | \$254 | \$38,625 |
| 15 | 9 | WELL SCREEN 6-INCH STAINLESS STEEL (0.06-INCH SLOT) | LF | 130 | \$210 | \$27,236 |
| 16 | 10 | GRAVEL PACK | LF | 290 | \$58 | \$16,905 |
| 17 | 11 | CEMENT SEAL | LF | 195 | \$41 | \$7,938 |
| 18 | 12 | HIGH PRESSURE JETTING | LS | 1 | \$23,829 | \$23,829 |
| 19 | 13 | DUAL SWAB AIRLIFT PUMPING | HR | 6.5 | \$2,525 | \$16,413 |
| 20 | 14 | CHEMICAL INJECTION | LS | 1 | \$12,900 | \$12,900 |
| 20 | 15 | CHEMICAL SWABBING (AGITATION) | HR | 9.75 | \$1,502 | \$14,640 |
| 20 | 16 | AIRLIFT REMOVAL AND DISPOSAL | HR | 6.5 | \$4,132 | \$26,860 |

| 21 | 17 | DISINFECTION | LS | 1 | \$7,320 | \$7,320 |
|---|--------------|-----------------------------------|------|--------|-------------------|---------------------|
| CONTRACTOR BID SHEET (CONTINUED) | | | | | | |
| SPECIFICATION SECTION NO. | BID ITEM NO. | WORK TASK | UNIT | AMOUNT | COST PER BID UNIT | TOTAL BID ITEM COST |
| 22 | 18 | SUBMERSIBLE PUMP AND MOTOR | LS | 1 | \$7,246 | \$7,246 |
| 22 | 19 | 3-INCH GALVANIZED DROP PIPE | LF | 315 | \$20 | \$6,286 |
| 22 | 20 | SUBMERSIBLE ELECTRIC CABLE | LF | 320 | \$3 | \$933 |
| 22 | 21 | SUBMERSIBLE PUMP CHECK VALVES | EA | 2 | \$358 | \$715 |
| 22 | 22 | STAINLESS STEEL AIRLINE AND GAGE | LF | 320 | \$2 | \$715 |
| 22 | 23 | ELECTRICAL CONTROLS UPGRADE | LS | 1 | \$3,125 | \$3,125 |
| 22 | 24 | DISSIMILAR METAL INSULATORS | EA | 14 | \$180 | \$2,515 |
| 22 | 25 | DISCHARGE HEAD AND SURFACE PIPING | LS | 1 | \$10,959 | \$10,959 |
| 22 | 26 | PUMP INSTALLATION | LS | 1 | \$14,640 | \$14,640 |
| 23 | 27 | WELL FLUSHING | LS | 1 | \$3,504 | \$3,504 |
| 24 | 28 | SITE CLEAN UP | LS | 1 | \$2,336 | \$2,336 |
| TOTAL | | | | | | \$399,887.95 |

ACKNOWLEDGMENT

A notary public or other officer completing this certificate verifies only the identity of the individual who signed the document to which this certificate is attached, and not the truthfulness, accuracy, or validity of that document.

State of California
County of VENTURA)

On 12-14-2021 before me, WILLIAM T ADAMS Notary Public
(insert name and title of the officer)

personally appeared WALTER RAY REECE JR
who proved to me on the basis of satisfactory evidence to be the person(s) whose name(s) is/are subscribed to the within instrument and acknowledged to me that he/she/they executed the same in his/her/their authorized capacity(ies), and that by his/her/their signature(s) on the instrument the person(s), or the entity upon behalf of which the person(s) acted, executed the instrument.

I certify under PENALTY OF PERJURY under the laws of the State of California that the foregoing paragraph is true and correct.

WITNESS my hand and official seal.

Signature William T. Adams (Seal)

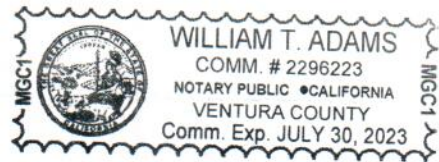

RE: BID BOND
DOCUMENT 004313

ACKNOWLEDGMENT

A notary public or other officer completing this certificate verifies only the identity of the individual who signed the document to which this certificate is attached, and not the truthfulness, accuracy, or validity of that document.

State of California
County of VENTURA

On 12-14-2021 before me, WILLIAM T ADAMS Notary Public
(insert name and title of the officer)

personally appeared WALTER RAY REECE JR
who proved to me on the basis of satisfactory evidence to be the person(s) whose name(s) is/are
subscribed to the within instrument and acknowledged to me that he/she/they executed the same in
his/her/their authorized capacity(ies), and that by his/her/their signature(s) on the instrument the
person(s), or the entity upon behalf of which the person(s) acted, executed the instrument.

I certify under PENALTY OF PERJURY under the laws of the State of California that the foregoing
paragraph is true and correct.

WITNESS my hand and official seal.

Signature William T. Adams (Seal)

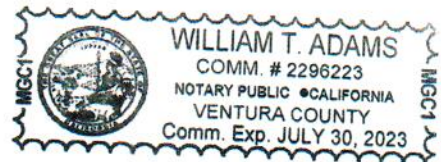

RE: BID BOND
DOCUMENT 004313

BID BOND

(Note: If Bidder is providing a bid bond as its bid security, Bidder must use this form, NOT a surety company form.)

KNOW ALL PERSONS BY THESE PRESENTS:

That the undersigned, General Pump Company, Inc., as Principal ("Principal"), and Travelers Casualty and Surety Company of America, as Surety ("Surety"), a corporation organized and existing under and by virtue of the laws of the State of Connecticut and authorized to do business as a surety in the State of California, are held and firmly bound unto the Oxnard Union High School District ("District") of Ventura County, State of California, as Obligee, in an amount equal to ten percent (10%) of the Base Bid plus alternates, in the sum of

Ten Percent (10%) of the Total Amount Bid Dollars (\$ 10%)

lawful money of the United States of America, for the payment of which sum well and truly to be made, we, and each of us, bind ourselves, our heirs, executors, administrators, successors, and assigns, jointly and severally, firmly by these presents.

THE CONDITION OF THIS OBLIGATION IS SUCH that whereas the Principal has submitted a bid to the District for all Work specifically described in the accompanying bid for the following project: **Bid 654 RIO MESA HIGH SCHOOL WELL NO. 2 REHABILITATION** ("Project" or "Contract").

NOW, THEREFORE, if the Principal is awarded the Contract and, within the time and manner required under the Contract Documents, after the prescribed forms are presented to Principal for signature, enters into a written contract, in the prescribed form in accordance with the bid, and files two bonds, one guaranteeing faithful performance and the other guaranteeing payment for labor and materials as required by law, and meets all other conditions to the Contract between the Principal and the Obligee becoming effective, or if the Principal shall fully reimburse and save harmless the Obligee from any damage sustained by the Obligee through failure of the Principal to enter into the written contract and to file the required performance and labor and material bonds, and to meet all other conditions to the Contract between the Principal and the Obligee becoming effective, then this obligation shall be null and void; otherwise, it shall be and remain in full force and effect. The full payment of the sum stated above shall be due immediately if Principal fails to execute the Contract within ten (10) days of the date of the District's Notice of Award to Principal.

Surety, for value received, hereby stipulates and agrees that no change, extension of time, alteration or addition to the terms of the Contract or the call for bids, or to the work to be performed thereunder, or the specifications accompanying the same, shall in any way affect its obligation under this bond, and it does hereby waive notice of any such change, extension of time, alteration or addition to the terms of the Contract or the call for bids, or to the work, or to the specifications.

**Bid 654
Rio Mesa High School Well No.2
Rehabilitation
RMHS**

**OXNARD UNION HSD
DIVISION ZERO-20**

In the event suit is brought upon this bond by the Obligee and judgment is recovered, the Surety shall pay all costs incurred by the Obligee in such suit, including a reasonable attorneys' fee to be fixed by the Court.

If the District awards the bid, the security of unsuccessful bidder(s) shall be returned within sixty (60) days from the time the award is made. Unless otherwise required by law, no bidder may withdraw its bid for ninety (90) days after the date of the bid opening.

IN WITNESS WHEREOF, this instrument has been duly executed by the Principal and Surety above named, on the 9th day of December, 2021.

General Pump Company, Inc.

Principal

[Signature]
By

Travelers Casualty and Surety Company of America
Surety

[Signature]
By Misty R. Hemje, Attorney-In-Fact

Arthur J. Gallagher & Co.
Name of California Agent of Surety

595 Market Street, Suite 2100, San Francisco, CA 94105
Address of California Agent of Surety

415-546-9300
Telephone Number of California Agent of Surety

Bidder must attach Power of Attorney and Certificate of Authority for Surety and a Notarial Acknowledgment for all Surety's signatures. The California Department of Insurance must authorize the Surety to be an admitted Surety Insurer.

END OF DOCUMENT

Bid 654
Rio Mesa High School Well No.2
Rehabilitation
RMHS

OXNARD UNION HSD
DIVISION ZERO-21

ACKNOWLEDGMENT

A notary public or other officer completing this certificate verifies only the identity of the individual who signed the document to which this certificate is attached, and not the truthfulness, accuracy, or validity of that document.

State of California

County of Contra Costa

On December 9, 2021 before me, Gillian C. Bhaskaran, Notary Public
(insert name and title of the officer)

personally appeared Misty R. Hemje
who proved to me on the basis of satisfactory evidence to be the person(s) whose name(s) is/are subscribed to the within instrument and acknowledged to me that he/she/they executed the same in his/her/their authorized capacity(ies), and that by his/her/their signature(s) on the instrument the person(s), or the entity upon behalf of which the person(s) acted, executed the instrument.

I certify under PENALTY OF PERJURY under the laws of the State of California that the foregoing paragraph is true and correct.

WITNESS my hand and official seal.

Signature *Gillian C. Bhaskaran* (Seal)

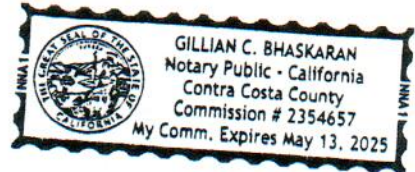



**Travelers Casualty and Surety Company of America
Travelers Casualty and Surety Company
St. Paul Fire and Marine Insurance Company**

POWER OF ATTORNEY

KNOW ALL MEN BY THESE PRESENTS: That Travelers Casualty and Surety Company of America, Travelers Casualty and Surety Company, and St. Paul Fire and Marine Insurance Company are corporations duly organized under the laws of the State of Connecticut (herein collectively called the "Companies"), and that the Companies do hereby make, constitute and appoint **MISTY R HEMJE** of **SAN FRANCISCO, California**, their true and lawful Attorney(s)-in-Fact to sign, execute, seal and acknowledge any and all bonds, recognizances, conditional undertakings and other writings obligatory in the nature thereof on behalf of the Companies in their business of guaranteeing the fidelity of persons, guaranteeing the performance of contracts and executing or guaranteeing bonds and undertakings required or permitted in any actions or proceedings allowed by law.

IN WITNESS WHEREOF, the Companies have caused this instrument to be signed, and their corporate seals to be hereto affixed, this 21st day of April, 2021.



State of Connecticut

City of Hartford ss.

By:
Robert L. Raney, Senior Vice President

On this the 21st day of April, 2021, before me personally appeared **Robert L. Raney**, who acknowledged himself to be the Senior Vice President of each of the Companies, and that he, as such, being authorized so to do, executed the foregoing instrument for the purposes therein contained by signing on behalf of said Companies by himself as a duly authorized officer.

IN WITNESS WHEREOF, I hereunto set my hand and official seal.

My Commission expires the 30th day of June, 2026



Anna P. Nowik, Notary Public

This Power of Attorney is granted under and by the authority of the following resolutions adopted by the Boards of Directors of each of the Companies, which resolutions are now in full force and effect, reading as follows:

RESOLVED, that the Chairman, the President, any Vice Chairman, any Executive Vice President, any Senior Vice President, any Vice President, any Second Vice President, the Treasurer, any Assistant Treasurer, the Corporate Secretary or any Assistant Secretary may appoint Attorneys-in-Fact and Agents to act for and on behalf of the Company and may give such appointee such authority as his or her certificate of authority may prescribe to sign with the Company's name and seal with the Company's seal bonds, recognizances, contracts of indemnity, and other writings obligatory in the nature of a bond, recognizance, or conditional undertaking, and any of said officers or the Board of Directors at any time may remove any such appointee and revoke the power given him or her; and it is

FURTHER RESOLVED, that the Chairman, the President, any Vice Chairman, any Executive Vice President, any Senior Vice President or any Vice President may delegate all or any part of the foregoing authority to one or more officers or employees of this Company, provided that each such delegation is in writing and a copy thereof is filed in the office of the Secretary; and it is

FURTHER RESOLVED, that any bond, recognizance, contract of indemnity, or writing obligatory in the nature of a bond, recognizance, or conditional undertaking shall be valid and binding upon the Company when (a) signed by the President, any Vice Chairman, any Executive Vice President, any Senior Vice President or any Vice President, any Second Vice President, the Treasurer, any Assistant Treasurer, the Corporate Secretary or any Assistant Secretary and duly attested and sealed with the Company's seal by a Secretary or Assistant Secretary; or (b) duly executed (under seal, if required) by one or more Attorneys-in-Fact and Agents pursuant to the power prescribed in his or her certificate or their certificates of authority or by one or more Company officers pursuant to a written delegation of authority; and it is

FURTHER RESOLVED, that the signature of each of the following officers: President, any Executive Vice President, any Senior Vice President, any Vice President, any Assistant Vice President, any Secretary, any Assistant Secretary, and the seal of the Company may be affixed by facsimile to any Power of Attorney or to any certificate relating thereto appointing Resident Vice Presidents, Resident Assistant Secretaries or Attorneys-in-Fact for purposes only of executing and attesting bonds and undertakings and other writings obligatory in the nature thereof, and any such Power of Attorney or certificate bearing such facsimile signature or facsimile seal shall be valid and binding upon the Company and any such power so executed and certified by such facsimile signature and facsimile seal shall be valid and binding on the Company in the future with respect to any bond or understanding to which it is attached.

I, Kevin E. Hughes, the undersigned, Assistant Secretary of each of the Companies, do hereby certify that the above and foregoing is a true and correct copy of the Power of Attorney executed by said Companies, which remains in full force and effect.

Dated this 9th day of December, 2021



Kevin E. Hughes, Assistant Secretary

To verify the authenticity of this Power of Attorney, please call us at 1-800-421-3880.
Please refer to the above-named Attorney(s)-in-Fact and the details of the bond to which this Power of Attorney is attached.

Nº 6516

STATE OF CALIFORNIA
DEPARTMENT OF INSURANCE
SAN FRANCISCO

Amended

Certificate of Authority

THIS IS TO CERTIFY, That, pursuant to the Insurance Code of the State of California,

Travelers Casualty and Surety Company of America

of Hartford, Connecticut, organized under the laws of Connecticut, subject to its Articles of Incorporation or other fundamental organizational documents, is hereby authorized to transact within this State, subject to all provisions of this Certificate, the following classes of insurance: Fire, Marine, Surety, Disability, Plate Glass, Liability, Workers' Compensation, Common Carrier Liability, Boiler and Machinery, Burglary, Credit, Sprinkler, Team and Vehicle, Automobile, Aircraft, and Miscellaneous as such classes are now or may hereafter be defined in the Insurance Laws of the State of California.

THIS CERTIFICATE is expressly conditioned upon the holder hereof now and hereafter being in full compliance with all, and not in violation of any, of the applicable laws and lawful requirements made under authority of the laws of the State of California as long as such laws or requirements are in effect and applicable, and as such laws and requirements now are, or may hereafter be changed or amended.

IN WITNESS WHEREOF, effective as of the 1st day of July, 1997, I have hereunto set

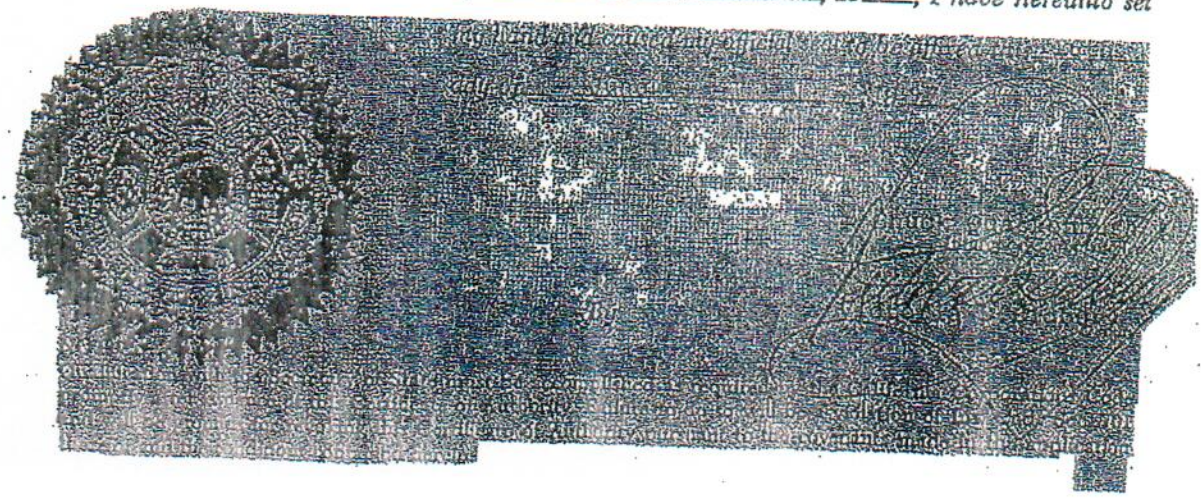



- Company Profile
- Company Search
- Company Search Results
- Company Information
- Old Company Names
- Agent for Service
- Reference Information
- NAIC Group List
- Lines of Business
- Workers' Compensation Complaint and Request for Action/Appeals Contact Information
- Financial Statements PDF's
- Annual Statements
- Quarterly Statements
- Company Complaint
- Company Performance & Comparison Data
- Company Enforcement Action
- Composite Complaints Studies
- Additional Info
- Find A Company Representative In Your Area
- View Financial Disclaimer

COMPANY PROFILE

Company Information

TRAVELERS CASUALTY AND SURETY COMPANY OF AMERICA
ONE TOWER SQUARE
HARTFORD, CT 06183

Old Company Names

Effective Date

AETNA CASUALTY & SURETY COMPANY OF AMERICA 07/01/1997

Agent For Service

Melissa DeKoven
 2710 Gateway Oaks Drive, Suite 150N
 Sacramento CA 95833-3505

Reference Information

| | |
|--------------------------------|---------------------|
| NAIC #: | 31194 |
| California Company ID #: | 2444-8 |
| Date Authorized in California: | 07/31/1981 |
| License Status: | UNLIMITED-NORMAL |
| Company Type: | Property & Casualty |
| State of Domicile: | CONNECTICUT |

[back to top](#)

NAIC Group List

NAIC Group #: **3548** Travelers Grp

Lines Of Business

The company is authorized to transact business within these lines of insurance. For an explanation of any of these terms, please refer to the [glossary](#).

- AIRCRAFT
- AUTOMOBILE
- BOILER AND MACHINERY
- BURGLARY
- COMMON CARRIER LIABILITY
- CREDIT
- DISABILITY
- FIRE
- LIABILITY
- MARINE
- MISCELLANEOUS
- PLATE GLASS
- SPRINKLER



ADDENDUM 1

Dated: December 8, 2021

All interested parties seeking to submit responses to the Oxnard Union High School District's Bid #654 shall incorporate this addendum into the Bid Documents, and mark having received this notice on the Bid Form.

The Oxnard Union High School District hereby amends Bid 654 Well #2 Rehabilitation at Rio Mesa High School, as follows:

THE FOLLOWING WELL SPECIFICATIONS SECTIONS SHALL REPLACE THE SECTIONS FOUND IN THE ORIGINAL TECHNICAL SPECIFICATIONS.

Plate 5 shall be replaced with the new drawing and Plate 4A shall be added.

SECTION 13 – CALIPER SURVEY AND DEVIATION SURVEY (BID ITEM NO. 4)

Scope

This item shall consist of furnishing professional logging services for the caliper survey and a deviation survey (gyro-directional survey) of the existing well casing and screen sections.

Construction Materials

The Contractor shall furnish services for a caliper log in the well casing and screen sections. The caliper tool shall have the ability to measure diameters up to 24 inches. The Contractor is advised that many of the available caliper tools do not perform adequately. It will be the Contractor's responsibility to deliver a usable caliper log. A record copy of the caliper survey shall be delivered to the Engineering Geologist upon completion of the log. Upon completion of the caliper log, five (5) final quality copies of the caliper survey shall be provided to the Engineering Geologist along with an electronic copy of the data in LAS and PDF formats.

The Contractor shall furnish services for a deviation survey in the well casing and screen sections. It will be the Contractor's responsibility to deliver a usable deviation log. A



record copy of the deviation survey shall be delivered to the Engineering Geologist upon completion of the log. Upon completion of the deviation survey, five (5) final quality copies of the survey shall be provided to the Engineering Geologist along with an electronic copy of the data in LAS and PDF formats.

Measurement and Payment

for

Caliper surveying and deviation logging of the well casing and screen intervals shall be paid on a lump sum basis for the unit price bid for Bid Item No. 4. Payment shall be considered full compensation for all labor, tools, equipment, insurance, and conducting all work necessary and incidental to completion of the work.



SECTION 14 - GRAVEL BACKFILL AND BENTONITE OR CEMENT SEAL (BID ITEM NO. 5)

Scope

This item shall consist of providing and installing 90 feet of clean washed coarse-grained sand or fine gravel (pea gravel) in the lower portion of the well and a 10-foot bentonite seal, as specified herein and shown on Plate 4. Alternatively, 60 feet of clean washed coarse-grained sand or fine gravel (pea gravel) shall be installed in the lower portion of the well along with a 25-foot cement seal, as specified herein and shown on Plate 4A.

Construction Materials

All gravel/coarse-grained sand used to backfill the 10-inch-diameter well casing shall be hard and washed clean of silt and fine sand and free of organic materials and foreign matter.

The manufacturer shall be identified and a description of the gravel packing materials proposed for use shall be provided with the Contractor's bid package. Transportation and storage of gravel shall be conducted using super sacks. Bulk delivery will not be allowed.

The bentonite seal material shall be installed using coated premium sodium bentonite pellets of the type that is manufactured specifically for well sealing.

The cement seal material shall consist of 80 gallons of a neat cement with approximately 5 percent bentonite added.

Construction Methods

Gravel/coarse sand fill shall be installed in the original well casing from an approximate depth of 585 to 495 feet bgs using a construction tremie pipe. The use of clean water and a gravel pump will be required. As the gravel settles, more shall be added. The gravel shall be sounded and topped off at the designated depth in preparation for bentonite seal placement.

Following gravel backfill placement, a 10-foot bentonite seal shall be installed from approximately 495 to 485 feet bgs. The bentonite seal shall be installed utilizing tremie pipe for installation. The tremie pipe shall be set at a depth of approximately 480 feet or lower.

Alternatively, following gravel backfill placement, a 25-foot cement seal shall be installed from approximately 525 to 500 feet bgs. The cement seal shall be installed utilizing tremie pipe and grout pump for installation. The tremie pipe shall be set at a depth of approximately 2 feet above the top of the gravel backfill (approximately 523 feet) and



installed using the positive displacement method. After the 80 gallons of cement has been pumped the tremie pipe shall be flushed with the same amount of fresh water. Fifty gallons of fresh water shall be installed through the 2-inch diameter tremie pipe prior to lifting the pipe up to 500 feet. After raising the tremie pipe to 500 feet the remaining 30 gallons shall be added to clear the tremie prior to removal.

Measurement and Payment

Payment for furnishing and installing the gravel fill and bentonite or cement seal shall be made on a lump sum basis at the unit price bid for Bid Item No. 5. Payment shall be considered full compensation for furnishing all labor, materials, tools, and equipment necessary and incidental to completion of the work.

SECTION 15 – WELL CASING AND SCREEN (BID ITEM NOS. 6 THROUGH 9)

Scope

This item shall consist of providing and installing a well casing and screen liner assembly with an end cap, as specified herein and shown on Plate 4. Prior to conducting any well modification work the Contractor shall obtain a well modification permit from the Ventura County Watershed Protection District (County).

Construction Materials

1. 8-Inch Nominal Diameter Stainless Steel Casing: The upper 8-inch nominal diameter casing shall be stainless steel manufactured in accordance with ASTM Standard A-312 or A-778 specifications having a minimum wall thickness of 1/4-inch (0.250 inches). The well liner casing sections shall be plain beveled ends to facilitate butt welding connections. The well liner casing sections shall be fitted with lifting lugs to facilitate installation.
2. 8-Inch To 6-Inch Liner Casing Reducer: The nominal 8-inch-diameter to 6-inch-diameter casing liner reducer shall be Type 304L stainless steel manufactured in accordance with ASTM Standard A-312 or A-778 specifications and have a minimum wall thickness of 0.25-inch. The final wall thickness used shall be adequate to protect against collapse during installation and subsequent production of the well. The well liner reducer shall be plain end construction with beveled ends for butt welding.
3. 6-Inch Nominal Diameter Stainless Steel Casing: The lower 6-inch nominal diameter casing shall be stainless steel manufactured in accordance with ASTM Standard A-139 Grade B or A-53 Grade B having a minimum wall thickness of 1/4-inch (0.25 inches). The well liner casing sections shall be plain beveled ends to facilitate butt



welding connections. The well liner casing sections shall be fitted with lifting lugs. The lugs shall be of the same material as the well casing.

4. 6-Inch Nominal Diameter Stainless Steel Screen: The 6-inch nominal diameter well screen liner shall be Type 304L, stainless steel continuous wire wrap screen of the type manufactured by Roscoe Moss Company, Johnson Screens, or approved equal, with an 0.060-inch slot between the surface wires. The wrap wire shall have a minimum height (altitude) of 0.14 inch and a minimum width of 0.17 inch. The screen shall have a minimum of 32 vertical rods and the rods shall have a minimum diameter of 0.15 inch that provides a minimum cross-sectional area of 0.58 square inches. The well screen design shall provide a minimum collapse strength of 194 pound per square inch (psi) and a minimum safe hanging weight of 6,300 pounds. Screen sections shall be manufactured complete with stainless steel weld rings attached at each end having a minimum wall thickness of 0.25-inch. The weld rings shall be fitted with stainless steel lifting lugs to facilitate centering and connection of each joint. The bottom of the screen section shall be fitted with a rounded end cap manufactured of Type 304L stainless steel material. **The Contractor shall submit the well screen manufacturer's specifications to the District with its bid.**

Construction Methods

Upon the completion of backfill placement and bentonite or cement seal installation; the Contractor shall install the well liner assembly at the intervals indicated on Plate 4 (or 4A).

The 8-inch-diameter casing and screen assemblages shall be straight. All field joints shall be properly butt welded during installation with a minimum of two passes per circumference. During installation the lifting lugs on both the 6-inch-diameter casing and 8-inch-diameter casing shall be removed. Permanent liner/tremie guide lugs shall be installed every 20 feet from an approximate depth of 190 feet bgs up to ground surface. The guide lugs shall have a rounded half moon shape as shown in Figure 2 – Half Moon Tremie and Liner Guide Lugs to prevent hanging up on installation.

The liner shall be suspended in tension from the surface by means of an appropriate hanger or clamp. The bottom of the casing shall be at a sufficient distance above the casing fill and seal to ensure that the well liner assemblage is not supported from the bottom.

All field-welding shall be performed in accordance with American Welding Society Standards. All welding rods shall be new and designed for stainless steel material.

A construction tremie shall be installed for gravel pack and cement seal placement and shall be a nominal 2-inch-diameter, flush threaded, steel or PVC tubing. The construction tremie shall be installed prior to the upper portion of the 8-inch-diameter nominal liner casing sections are installed, and be installed to an approximate depth of 190 feet bgs.

The tremie and liner guide lugs shall be placed in such a manner as to facilitate a 2.375-inch-outside-diameter construction tremie pipe to be installed along with the 8-inch-diameter blank liner casing. Lugs placed opposite the tremie guide lugs shall be sized by the Contractor to allow cement to seal around the casing and not interfere with liner installation. Figure 3 – Tremie Guide Lug Placement shows a conceptual drawing of the type of protection intended.

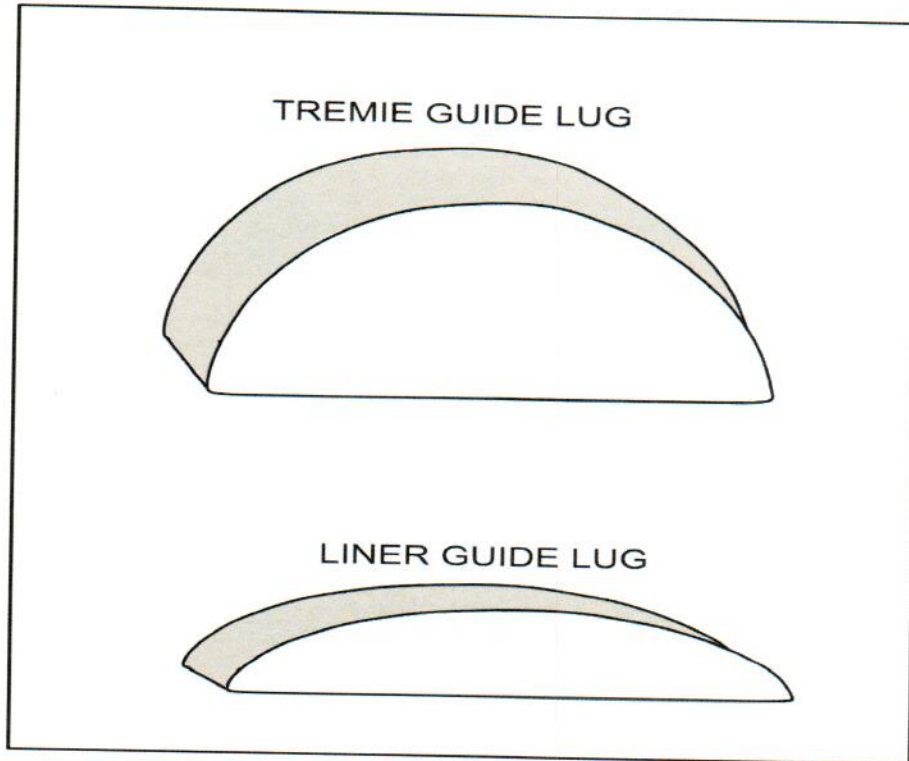

Figure 2 – Half Moon Tremie and Liner Guide Lugs

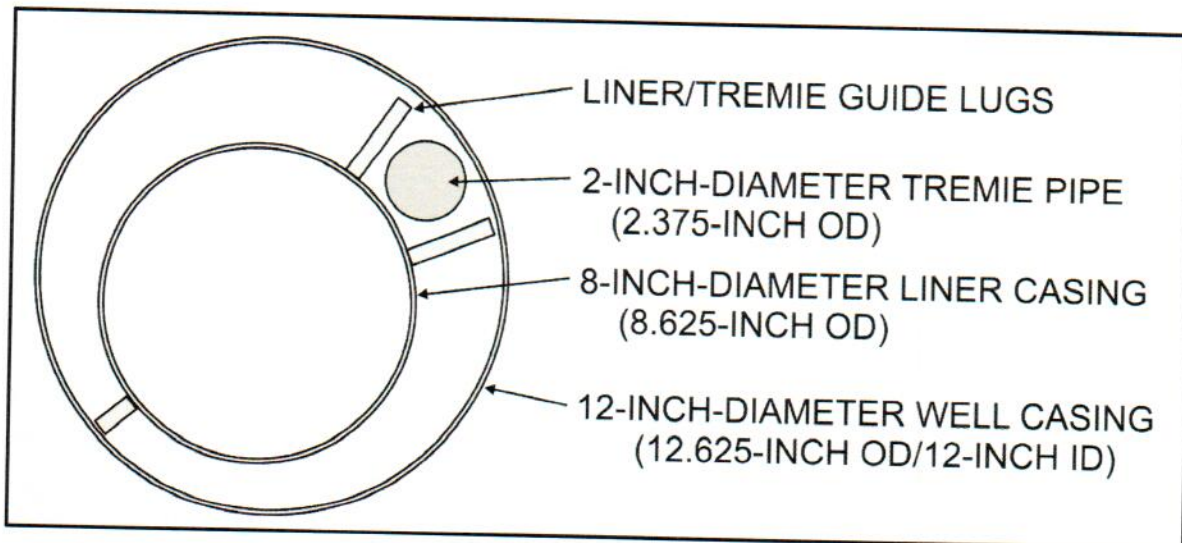

Figure 3 – Tremie and Liner Guide Lug Placement

The stainless steel well casing shall extend 18 inches above the existing concrete slab to facilitate the wellhead plumbing design shown on Plate 5 – Wellhead Design Drawing. Subsequently, the 12-inch-diameter low carbon steel casing shall be extended up 14 inches and fitted with a flange to accommodate the wellhead plumbing shown on Plate 5.

Measurement and Payment

1. 8-Inch Nominal Diameter Stainless Steel Casing: The 8-inch nominal diameter Type 304L stainless steel casing having a 0.250-inch wall thickness for the upper portion of the well liner will be paid for on a per linear foot basis in place at the unit price bid for Bid Item No. 6. Payment shall be considered full compensation for furnishing all labor, materials, tools, fuel, and equipment necessary and incidental to completion of the work.
2. 8-Inch-Diameter by 6-Inch-Diameter Stainless Steel Reducer: The nominal 8-inch-diameter by 6-inch-diameter Type 304L stainless steel reducer will be paid for on a lump sum basis in place at the unit price bid for Bid Item No. 7. Payment shall be considered full compensation for furnishing all labor, materials, tools, and equipment necessary and incidental to completion of the work.
3. 6-Inch Nominal Diameter Stainless Steel Casing: The 6-inch nominal diameter Type 304L stainless steel casing having a 0.25-inch wall thickness will be paid for on a per linear foot basis in place at the unit price bid for Bid Item No. 8. Payment shall be considered full compensation for furnishing all labor, materials, tools, and equipment necessary and incidental to completion of the work.



4. 6-Inch Nominal Diameter Stainless Steel Liner Screen: The 6-inch nominal diameter Type 304L stainless steel wire wrap screen with end cap will be paid for on a per linear foot basis in place at the unit price bid for Bid Item No. 9. Payment shall be considered full compensation for furnishing all labor, materials, tools, and equipment necessary and incidental to completion of the work.

TABLE OF CONTENTS**Procurement and Contracting Requirements**

| <u>Division 0</u> | <u>Section</u> | <u>Title</u> |
|-------------------|----------------|--------------------|
| | 00 01 01 | Project Title Page |
| | 00 01 10 | Table of Contents |

Solicitation

| <u>Division 0</u> | <u>Section</u> | <u>Title</u> |
|-------------------|----------------|-------------------|
| | 00 11 16 | Notice to Bidders |

Instructions for Procurement

| <u>Division 0</u> | <u>Section</u> | <u>Title</u> |
|-------------------|----------------|-------------------------|
| | 00 21 13 | Instructions to Bidders |

Procurement Forms and Supplements

| <u>Division 0</u> | <u>Section</u> | <u>Title</u> |
|-------------------|----------------|---|
| | 00 41 13 | Bid Form and Proposal |
| | 00 43 13 | Bid Bond |
| | 00 43 36 | Designated Subcontractors List |
| | 00 45 01 | Site Visit Certification |
| | 00 45 19 | Non-Collusion Declaration |
| | 00 45 19.01 | Iran Contracting Act Certification |
| | 00 45 26 | Workers' Compensation Certification |
| | 00 45 46.01 | Prevailing Wage and Related Labor Requirements Certification |
| | 00 45 46.02 | Disabled Veteran Business Enterprise Participation Certification |
| | 00 45 46.03 | Drug-Free Workplace Certification |
| | 00 45 46.04 | Tobacco-Free Environment Certification |
| | 00 45 46.05 | Hazardous Materials Certification |
| | 00 45 46.06 | Lead-Based Materials Certification |
| | 00 45 46.07 | Imported Materials Certification |
| | 00 45 46.08 | Criminal Background Investigation/Fingerprinting Certification |
| | 00 45 46.09 | Buy American Certification |
| | 00 45 46.10 | Roofing Project Certification |
| | 00 45 49 | Registered Subcontractors List |

Contracting Forms and Supplements

| <u>Division 0</u> | <u>Section</u> | <u>Title</u> |
|-------------------|----------------|---------------------------------|
| | 00 51 00 | Notice of Award |
| | 00 52 13 | Agreement Form – Stipulated Sum |
| | 00 55 00 | Notice to Proceed |

**Bid 654
Rio Mesa High School Well No.2
Rehabilitation
RMHS**

**OXNARD UNION HSD
DIVISION ZERO-2**

Project Forms

| <u>Division 0</u> | <u>Section</u> | <u>Title</u> |
|-------------------|----------------|----------------------------|
| | 00 61 13.13 | Performance Bond |
| | 00 61 13.16 | Payment Bond |
| | 00 63 57 | Proposed Change Order Form |
| | 00 65 36 | Guarantee Form |

Conditions of the Contract

| <u>Division 0</u> | <u>Section</u> | <u>Title</u> |
|-------------------|----------------|---|
| | 00 72 13 | General Conditions – Stipulated Sum |
| | 00 73 13 | Special Conditions |
| | 00 73 56 | Hazardous Materials Procedures and Requirements |

General Requirements

| <u>Division 1</u> | <u>Section</u> | <u>Title</u> |
|-------------------|----------------|-----------------|
| | 01 11 00 | Summary of Work |

Price and Payment Procedures

| <u>Division 1</u> | <u>Section</u> | <u>Title</u> |
|-------------------|----------------|-----------------------------------|
| | 01 25 13 | Product Options and Substitutions |

Administrative Requirements

| <u>Division 1</u> | <u>Section</u> | <u>Title</u> |
|-------------------|----------------|--------------------|
| | 01 31 19 | Project Meetings |
| | 01 32 13 | Scheduling of Work |
| | 01 33 00 | Submittals |
| | 01 35 13.23 | Site Standards |

Quality Requirements

| <u>Division 1</u> | <u>Section</u> | <u>Title</u> |
|-------------------|----------------|----------------------------|
| | 01 41 00 | Regulatory Requirements |
| | 01 42 13 | Abbreviations and Acronyms |
| | 01 42 19 | References |
| | 01 43 00 | Materials and Equipment |
| | 01 45 00 | Quality Control |

Temporary Facilities and Controls

| <u>Division 1</u> | <u>Section</u> | <u>Title</u> |
|-------------------|----------------|--|
| | 01 50 00 | Temporary Facilities and Controls |
| | 01 50 13 | Construction Waste Management and Disposal |

Execution and Closeout Requirements

| <u>Division 1</u> | <u>Section</u> | <u>Title</u> |
|-------------------|----------------|-------------------------------|
| | 01 71 23 | Field Engineering |
| | 01 73 29 | Cutting and Patching |
| | 01 76 00 | Alteration Project Procedures |

**Bid 654
Rio Mesa High School Well No.2
Rehabilitation
RMHS**

**OXNARD UNION HSD
DIVISION ZERO-3**

01 77 00

Contract Closeout and Final Cleaning

PLEASE NOTE: The Design Team will provide Drawings, Detailed Specifications and additional project information under separate cover.

(SEPARATE COVER DOCUMENTS AS A PART OF THIS BID PACKAGE)

Hopkins Groundwater Consultants Technical Plans and Specifications for:
Oxnard Union High School District Rio Mesa High School Well No. 2 Rehabilitation Project
Pages 1-30, Plates 1-8 Water Quality Test Reports 2 pages and Attachment B Video Survey
Summary Reports 4 pages and the Down Hole Video Survey consisting of 6 pages and
finally Attachment C Well No. 2 Pump Information and Design Curve.

END OF DOCUMENT

**Bid 654
Rio Mesa High School Well No.2
Rehabilitation
RMHS**

**OXNARD UNION HSD
DIVISION ZERO-4**

NOTICE TO BIDDERS

1. Notice is hereby given that the governing board ("Board") of the Oxnard Union High School District ("District") will receive electronic bids for the following project ("Project" or "Contract"): **Bid 654 Rio Mesa High School Well No. 2 Rehabilitation**

For an estimated project value of \$300,000 - \$400,000

Work Consists of:

Providing all Labor, Materials and Equipment Required or Necessary to Complete the Rehabilitation/Renovation & Repair of Well#2 including all Related components existing both above Grade at the Surface and Below Grade or Down Hole to the Point of Water Supply. There are 28 Individual Tasks Listed on the Contractor Bid Sheet Dated November 2020 From Hopkins Groundwater Consultants that will be performed by the C-57 Water Well Contractor who is awarded the Contract. Contractor shall Complete all work per the Scope of Work in Hopkins Groundwater Consultants Technical Plans and Specifications for: Oxnard Union High School District Rio Mesa High School Well No. 2 Rehabilitation Project Pages 1-30, Plates 1-8 Water Quality Test Reports 2 pages and Attachment B Video Survey Summary Reports 4 pages and the Down Hole Video Survey consisting of 6 pages and finally Attachment C Well No. 2 Pump Information and Design Curve.

2. To bid on this Project, the Bidder is required to possess one or more of the following State of California contractors' license(s): **C-57**. The Bidder's license(s) must remain active and in good standing throughout the term of the Contract.
3. To bid on this Project, the Bidder is required to be registered as a public works contractor with the Department of Industrial Relations pursuant to the Labor Code.
4. Contract Documents will be available on or after **November 15, 2021**, for review on the District's website, <https://www.oxnardunion.org/administrative-services/purchasing-warehousing/rfp/>.
5. **The District will only receive bids submitted electronically.** Bids will be received until 3:00 p.m., December 15, 2021 only at the following email address [Deanna.Rantz@oxnardunion.org], after which time the bids will be opened and posted on the District website. **Each bidder is solely responsible for timely submission of its bid; the District is not responsible for any technological issues in a bidder's ability to timely submit its bid or portion thereof.** Any claim by a bidder of error in its bid must be made in compliance with section 5100 et seq. of the Public Contract Code. Prior to posting bids, the District reserves the right to verify the genuineness of any bid security.

**Bid 654
Rio Mesa High School Well No.2
Rehabilitation
RMHS**

**OXNARD UNION HSD
DIVISION ZERO-5**

6. All bids shall be on the form provided by the District. Each bid must conform and be responsive to all pertinent Contract Documents, including, but not limited to, the Instructions to Bidders.
7. A bid bond by an admitted surety insurer on the form provided by the District, a cashier's check or a certified check, drawn to the order of the Oxnard Union High School District, in the amount of ten percent (10%) of the total bid price, must be submitted **in hard copy by the bid due date and time** to 1800 Solar Drive, Oxnard, CA 93030, Attn: Director of Purchasing. A copy of bid security shall accompany the electronic submission of the bid package. Bid Security must be submitted as a guarantee that the Bidder will, within ten (10) calendar days after the date of the Notice of Award, enter into a contract with the District for the performance of the services as stipulated in the bid.
8. A **mandatory** pre-bid conference and site visit will be held on **December 1, 2021, at 9:00. am. at Rio Mesa High School, 545 Central Ave, Oxnard Ca. (MEET AT EAST GATE TO CAMPUS), California.** All participants are required to sign in front of the Main Office Administration Building. Failure to attend or tardiness will render bid ineligible. Late arrivals will not be allowed to register on the sign in sheet.
9. **The Project Timeline is as follows:**

| | |
|--|------------------------------|
| Advertisements – Notice to Bidders | 11/14/21 & 11/21/21 |
| Mandatory Site Visit | 12/1/21 @ 9:00 a.m. |
| Pre-Qualification Submission Cut-Off | 12/1/21 @ 11.59 p.m. |
| Bidder Clarification Request Deadline | 12/8/21 @ 3:00 p.m. |
| Responsible Bidders Pre-Qualification Deadline | 12/8/21 @ 4:30 p.m. |
| Bids Due (Electronically) | 12/15/21 @ 3:00 p.m. |
| Bid Bond/Bid Security Due in Hard Copy | 12/15/21 @ 3:00 p.m. |
| Bid Review | 12/16/21 – 12/17/21 |
| Letter of Intent to Award | 12/17/21 |
| Board Award | January 2022 (Date TBD) |
| Notice of Award | January 2022 (Date TBD) |
| Notice to Proceed | 10 days from Notice of Award |
| Pre-Construction Meeting | TBD |
| Work Completion | April 1, 2022 |

**Bid 654
Rio Mesa High School Well No.2
Rehabilitation
RMHS**

**OXNARD UNION HSD
DIVISION ZERO-6**

10. The successful Bidder shall be required to furnish a 100% Performance Bond and a 100% Payment Bond if it is awarded the Contract for the Work. The successful Bidder may substitute securities for any monies withheld by the District to ensure performance under the Contract, in accordance with the provisions of section 22300 of the Public Contract Code.
11. The Contractor and all Subcontractors under the Contractor shall pay all workers on all Work performed pursuant to this Contract not less than the general prevailing rate of per diem wages and the general prevailing rate for holiday and overtime work as determined by the Director of the Department of Industrial Relations, State of California, for the type of work performed and the locality in which the work is to be performed within the boundaries of the District, pursuant to section 1770 et seq. of the California Labor Code. Prevailing wage rates are also available from the District or on the Internet at: <<http://www.dir.ca.gov>> .
12. This Project is subject to labor compliance monitoring and enforcement by the Department of Industrial Relations pursuant to Labor Code section 1771.4 and subject to the requirements of Title 8 of the California Code of Regulations. The successful Bidder shall comply with all requirements of Division 2, Part 7, Chapter 1, Articles 1-5 of the Labor Code.
13. The Contractor and all Subcontractors under the Contractor shall comply with applicable federal, State, and local requirements relating to COVID-19 or other public health emergency/epidemic/pandemic including, if required, preparing, posting, and implementing a Social Distancing Protocol.
14. The District shall award the Contract, if it awards it at all, to the lowest responsive responsible bidder based upon the base bid amount only.
15. The Board reserves the right to reject any and all bids and/or waive any irregularity in any bid received. If the District awards the Contract, the security of unsuccessful bidder(s) shall be returned within sixty (60) days from the time the award is made. Unless otherwise required by law, no bidder may withdraw its bid for ninety (90) days after the date of the bid opening.

END OF DOCUMENT

Publication Dates: 11/14/21 & 11/21/21

Bid 654
Rio Mesa High School Well No.2
Rehabilitation
RMHS

OXNARD UNION HSD
DIVISION ZERO-7

INSTRUCTIONS TO BIDDERS

Bidders shall follow the instructions in this document, and shall submit all documents, forms, and information required for consideration of a bid.

Oxnard Union High School District ("District") will evaluate information submitted by the apparent low Bidder and, if incomplete or unsatisfactory to District, Bidder's bid may be rejected at the sole discretion of District.

16. Bids are requested for a general construction contract, or work described in general, for the following project ("Project" or "Contract"):

Bid 654 RIO MESA HIGH SCHOOL WELL NO.2 REHABILITATION

17. A Bidder and its subcontractors must possess the appropriate State of California contractors' license and must maintain the license throughout the duration of the project. Bidders must also be registered as a public works contractor with the Department of Industrial Relations pursuant to the Labor Code. Bids submitted by a contractor who is not properly licensed or registered shall be deemed nonresponsive and will not be considered.
17. District will receive bids submitted electronically from bidders as stipulated in the Notice to Bidders.
 - a. Email subject line must include the name of the Bidder, name of the Project, the Project Number and/or bid number, and time of bid opening.
 - b. Bids must be electronically submitted to the following email address [Deanna.Rantz@oxnardunion.org], by date and time shown in the Notice to Bidders.
 - c. Each bidder is solely responsible for timely submission of its bid; the District is not responsible for any technological issues affecting a bidder's ability to timely submit its bid or portion thereof.
 - d. Bid emails must attach all documents as required herein.
18. Bidders must submit bids on the documents titled Bid Form and Proposal and must submit all other required District forms. Bids not submitted on the District's required forms shall be deemed nonresponsive and shall not be considered. Additional sheets required to fully respond to requested information are permissible.
19. Bidders shall not modify the Bid Form and Proposal or qualify their bids. Bidders shall not submit to the District a re-formatted, re-typed, altered, modified, or otherwise recreated version of the Bid Form and Proposal or other District-provided document.

20. Bids shall be clearly written and without erasure or deletions. District reserves the right to reject any bid containing erasures, deletions, or illegible contents.
21. Bidders must supply all information required by each Bid Document. Bids must be full and complete. District reserves the right in its sole discretion to reject any bid as nonresponsive as a result of any error or omission in the bid. Bidders must complete and submit all of the following documents with the Bid Form and Proposal:
 - a. "Photocopy of Bid Bond on the District's form", or other security. (Original due in hard copy by bid due date and time)
 - b. Exhibit A Bid Tabulation Sheet
 - c. Designated Subcontractors List.
 - d. Site Visit Certification.
 - e. Non-Collusion Declaration.
22. Bidders must submit with their bids a (i) a cashier's check or (ii) a certified check payable to District, or (iii) a bid bond" by an admitted surety insurer of not less than ten percent (10%) of amount of Base Bid plus all additive alternates ("Bid Bond"), **in hard copy, no later than the bid due date and time**, to 1800 Solar Drive, Oxnard, CA 93030, Attn: Director of Purchasing. If Bidder chooses to provide a Bid Bond as security, Bidder must use the required form of corporate surety provided by District. The Surety on Bidder's Bid Bond must be an insurer admitted in the State of California and authorized to issue surety bonds in the State of California. Bidder must deliver the original of the bid bond, cashier's check, or certified check to the location noted above, no later than the bid due date and time. Bids submitted without necessary bid security will be deemed nonresponsive and will not be considered.
23. If Bidder to whom the Contract is awarded fails or neglects to enter into the Contract and submit required bonds, insurance certificates, and all other required documents, within **TEN (10)** calendar days after the date of the Notice of Award, District may deposit Bid Bond, cashier's check, or certified check for collection, and proceeds thereof may be retained by District as liquidated damages for failure of Bidder to enter into Contract, in the sole discretion of District. It is agreed that calculation of damages District may suffer as a result of Bidder's failure to enter into the Contract would be extremely difficult and impractical to determine and that the amount of the Bidder's required bid security shall be the agreed and conclusively presumed amount of damages.
24. Bidders must submit with the bid the Designated Subcontractors List for those subcontractors who will perform any portion of Work, including labor, rendering of service, or specially fabricating and installing a portion of the Work or improvement according to detailed drawings contained in the plans and specifications, in excess of one half of one percent (0.5%) of total bid. Failure to submit this list when required by law shall result in bid being deemed nonresponsive and the bid will not be considered.

25. All of the listed subcontractors are required to be registered as a public works contractor with the Department of Industrial Relations pursuant to the Labor Code.
- a. An inadvertent error in listing the California contractor license number on the Designated Subcontractors List shall not be grounds for filing a bid protest or grounds for considering the bid nonresponsive if the correct contractor's license number is submitted to the District within 24 hours after the bid opening and the corrected number corresponds with the submitted name and location for that subcontractor.
 - b. An inadvertent error listing an unregistered subcontractor shall not be grounds for filing a bid protest or grounds for considering the bid nonresponsive provided that any of the following apply:
 - (1) The subcontractor is registered prior to the bid opening.
 - (2) The subcontractor is registered and has paid the penalty registration fee within 24 hours after the bid opening.
 - (3) The subcontractor is replaced by another registered subcontractor pursuant to Public Contract Code section 4107.
26. A mandatory pre-bid conference and site visit ("Site Visit") is required as referenced in the Notice to Bidders. Bidders must submit the Site Visit Certification with their Bid. District will transmit to all prospective Bidders of record such Addenda as District in its discretion considers necessary in response to questions arising at the Site Visit. Oral statements shall not be relied upon and will not be binding or legally effective. Addenda issued by the District as a result of the Site Visit, if any, shall constitute the sole and exclusive record and statement of the results of the Site Visit.
27. Bidders shall submit the Non-Collusion Declaration with their bids. Bids submitted without the Non-Collusion Declaration shall be deemed nonresponsive and will not be considered.
28. The Contractor and all Subcontractors under the Contractor shall pay all workers on all work performed pursuant to the Contract not less than the general prevailing rate of per diem wages and the general prevailing rate for holiday and overtime work as determined by the Director of the Department of Industrial Relations, State of California, for the type of work performed and the locality in which the work is to be performed within the boundaries of the District, pursuant to sections 1770 et seq. of the California Labor Code. Copies of the general prevailing rates of per diem wages for each craft, classification, or type of worker needed to execute the Contract, as determined by Director of the Department of Industrial Relations, are available upon request at the District's principal office. Prevailing wage rates are also available on the internet at <http://www.dir.ca.gov>.
29. Submission of bid signifies careful examination of Contract Documents and complete understanding of the nature, extent, and location of Work to be performed. Bidders must complete the tasks listed below as a condition to bidding, and submission of a bid shall constitute the Bidder's express representation to District that Bidder has fully completed the following:

Bid 654
Rio Mesa High School Well No.2
Rehabilitation
RMHS

OXNARD UNION HSD
DIVISION ZERO-10

- a. Bidder has visited the Site, if required, and has examined thoroughly and understood the nature and extent of the Contract Documents, Work, Site, locality, actual conditions, as-built conditions, and all local conditions and federal, state and local laws, and regulations that in any manner may affect cost, progress, performance, or furnishing of Work or that relate to any aspect of the means, methods, techniques, sequences, or procedures of construction to be employed by Bidder and safety precautions and programs incident thereto;
- b. Bidder has conducted or obtained and has understood all examinations, investigations, explorations, tests, reports, and studies that pertain to the subsurface conditions, as-built conditions, underground facilities, and all other physical conditions at or contiguous to the Site or otherwise that may affect the cost, progress, performance, or furnishing of Work, as Bidder considers necessary for the performance or furnishing of Work at the Contract Sum, within the Contract Time, and in accordance with the other terms and conditions of Contract Documents, including specifically the provisions of the General Conditions; and no additional examinations, investigations, explorations, tests, reports, studies, or similar information or data are or will be required by Bidder for such purposes;
- c. Bidder has correlated its knowledge and the results of all such observations, examinations, investigations, explorations, tests, reports, and studies with the terms and conditions of the Contract Documents;
- d. Bidder has given the District prompt written notice of all conflicts, errors, ambiguities, or discrepancies that it has discovered in or among the Contract Documents and the actual conditions, and the written resolution(s) thereof by the District is/are acceptable to Bidder;
- e. Bidder has made a complete disclosure in writing to the District of all facts bearing upon any possible interest, direct or indirect, that Bidder believes any representative of the District or other officer or employee of the District presently has or will have in this Contract or in the performance thereof or in any portion of the profits thereof;
- f. Bidder must, prior to bidding, perform the work, investigations, research, and analysis required by this document and that Bidder represented in its Bid Form and Proposal and the Agreement that it performed prior to bidding. Contractor under this Contract is charged with all information and knowledge that a reasonable bidder would ascertain from having performed this required work, investigation, research, and analysis. Bid prices must include entire cost of all work "incidental" to completion of the Work.
- g. Conditions Shown on the Contract Documents: Information as to underground conditions, as-built conditions, or other conditions or obstructions, indicated in the Contract Documents, e.g., on Drawings or in Specifications, has been obtained with reasonable care, and has been recorded in good faith. However, District only warrants, and Bidder may only rely, on the accuracy of limited types of information.

- (1) As to above-ground conditions or as-built conditions shown or indicated in the Contract Documents, there is no warranty, express or implied, or any representation express or implied, that such information is correctly shown or indicated. This information is verifiable by independent investigation and Bidder is required to make such verification as a condition to bidding. In submitting its Bid, Bidder shall rely on the results of its own independent investigation. In submitting its Bid, Bidder shall not rely on District-supplied information regarding above-ground conditions or as-built conditions.
 - (2) As to any subsurface condition shown or indicated in the Contract Documents, Bidder may rely only upon the general accuracy of actual reported depths, actual reported character of materials, actual reported soil types, actual reported water conditions, or actual obstructions shown or indicated. District is not responsible for the completeness of such information for bidding or construction; nor is District responsible in any way for any conclusions or opinions that the Bidder has drawn from such information; nor is the District responsible for subsurface conditions that are not specifically shown (for example, District is not responsible for soil conditions in areas contiguous to areas where a subsurface condition is shown).
- h. Conditions Shown in Reports and Drawings Supplied for Informational Purposes: Reference is made to the document entitled Geotechnical Data, and the document entitled Existing Conditions, for identification of:
 - (1) Subsurface Conditions: Those reports of explorations and tests of subsurface conditions at or contiguous to the Site that have been utilized by Architect in preparing the Contract Documents; and
 - (2) Physical Conditions: Those drawings of physical conditions in or relating to existing surface or subsurface structures at or contiguous to the Site that has been utilized by Architect in preparing the Contract Documents.
 - (3) These reports and drawings are **not** Contract Documents and, except for any "technical" data regarding subsurface conditions specifically identified in Geotechnical Data and Existing Conditions, and underground facilities data, Bidder may not in any manner rely on the information in these reports and drawings. Subject to the foregoing, Bidder must make its own independent investigation of all conditions affecting the Work and must not rely on information provided by District.
30. Bids shall be based on products and systems specified in Contract Documents or listed by name in Addenda. Whenever in the Specifications any materials, process, or article is indicated or specified by grade, patent, or proprietary name, or by name of manufacturer, that Specification shall be deemed to be followed by the words "or equal." Bidder may, unless otherwise stated, offer any material, process, or article that shall be substantially equal or better in every respect to that so indicated or specified. The District is not responsible and/or liable in any way for a Contractor's

damages and/or claims related, in any way, to that Contractor's basing its bid on any requested substitution that the District has not approved in advance and in writing. Contractors and materials suppliers who submit requests for substitutions prior to the award of the Contract must do so in writing and in compliance with Public Contract Code section 3400. All requests must comply with the following:

- a. District must receive any notice of request for substitution of a specified item a minimum of **TEN (10)** calendar days prior to bid opening. The Successful Bidder will not be allowed to substitute specified items unless properly noticed.
 - b. Within 35 days after the date of the Notice of Award, the Successful Bidder shall submit data substantiating the request(s) for all substitution(s) containing sufficient information to assess acceptability of product or system and impact on Project, including, without limitation, the requirements specified in the Special Conditions and the Specifications. Insufficient information shall be grounds for rejection of substitution.
 - c. Approved substitutions, if any, shall be listed in Addenda. District reserves the right not to act upon submittals of substitutions until after bid opening.
 - d. Substitutions may be requested after Contract has been awarded only if indicated in and in accordance with requirements specified in the Special Conditions and the Specifications.
31. All questions about the meaning or intent of the Contract Documents are to be directed via email to the District Director of Purchasing, Deanna.rantz@oxnardunion.org . RFI responses will be issued in writing by Addenda and posted on the District's website at <https://www.oxnardunion.org/administrative-services/purchasing-warehousing/rfp/> . Only questions answered by formal written Addenda will be binding. Oral and other interpretations or clarifications will be without legal effect.
32. Addenda may also be issued to modify other parts of the Contract Documents as deemed advisable by the District. Each Bidder must acknowledge each Addendum in its Bid Form and Proposal by number or its Bid shall be considered non-responsive. Each Addendum shall be part of the Contract Documents. A complete listing of Addenda may be secured from the District.
33. The District shall award the Contract, if it awards it at all, to the lowest responsive responsible bidder based on the criteria as indicated in the Notice to Bidders. In the event two or more responsible bidders submit identical bids, the District shall select the Bidder to whom to award the Contract by lot.
34. Discrepancies between written words and figures, or words and numerals, will be resolved in favor of figures or numerals.
35. Any bid protest by any Bidder regarding any other bid must be submitted in writing to the District, before 5:00 p.m. of the **THIRD (3rd)** business day following bid opening.

Bid 654
Rio Mesa High School Well No.2
Rehabilitation
RMHS

OXNARD UNION HSD
DIVISION ZERO-13

- a. Only a Bidder who has actually submitted a bid, and who could be awarded the Contract if the bid protest is upheld, is eligible to submit a bid protest. Subcontractors are not eligible to submit bid protests. A Bidder may not rely on the bid protest submitted by another Bidder.
 - b. A bid protest must contain a complete statement of any and all bases for the protest and all supporting documentation. Materials submitted after the bid protest deadline will not be considered.
 - c. The protest must refer to the specific portions of all documents that form the basis for the protest.
 - (1) Without limitation to any other basis for protest, an inadvertent error in listing the California contractor's license number on the Designated Subcontractors List shall not be grounds for filing a bid protest or grounds for considering the bid nonresponsive if the correct contractor's license number is submitted to the District within 24 hours after the bid opening and the corrected number corresponds with the submitted name and location for that subcontractor.
 - (2) Without limitation to any other basis for protest, an inadvertent error listing an unregistered subcontractor shall not be grounds for filing a bid protest or grounds for considering the bid nonresponsive provided that any of the following apply:
 - (a) The subcontractor is registered prior to the bid opening.
 - (b) The subcontractor is registered and has paid the penalty registration fee within 24 hours after the bid opening.
 - (c) The subcontractor is replaced by another registered subcontractor pursuant to Public Contract Code section 4107.
 - d. The protest must include the name, address and telephone number of the person representing the protesting party.
 - e. The party filing the protest must concurrently transmit a copy of the protest and any attached documentation to all other parties with a direct financial interest that may be adversely affected by the outcome of the protest. Such parties shall include all other bidders or proposers who appear to have a reasonable prospect of receiving an award depending upon the outcome of the protest.
 - f. The procedure and time limits set forth in this paragraph are mandatory and are each bidder's sole and exclusive remedy in the event of bid protest. Failure to comply with these procedures shall constitute a waiver of any right to further pursue the bid protest, including filing a Government Code Claim or legal proceedings.
36. The Bidder to whom Contract is awarded shall execute and submit the following documents by 5:00 p.m. of the **TENTH (10th)** calendar day following the date of

Bid 654
Rio Mesa High School Well No.2
Rehabilitation
RMHS

OXNARD UNION HSD
DIVISION ZERO-14

the Notice of Award. Failure to properly and timely submit these documents entitles District to reject the bid as nonresponsive.

- a. Agreement: To be executed by successful Bidder. Submit one (1) electronic copy, bearing an original signature.
 - b. Performance Bond (100%): On the form provided in the Contract Documents and fully executed as indicated on the form.
 - c. Payment Bond (Contractor's Labor and Material Bond) (100%): On the form provided in the Contract Documents and fully executed as indicated on the form.
 - d. Insurance Certificates and Endorsements as required.
 - e. Workers' Compensation Certification.
 - f. Prevailing Wage and Related Labor Requirements Certification.
 - g. Drug-Free Workplace Certification.
 - h. Tobacco-Free Environment Certification.
 - i. Hazardous Materials Certification.
 - j. Criminal Background Investigation/Fingerprinting Certification.
 - k. Registered Subcontractors List: Must include Department of Industrial Relations (DIR) registration number of each subcontractor for all tiers.
37. Time for Completion: District may issue a Notice to Proceed within **NINETY (90)** days from the date of the Notice of Award. Once Contractor has received the Notice to Proceed, Contractor shall complete the Work within the period of time indicated in the Contract Documents.
- a. In the event that the District desires to postpone issuing the Notice to Proceed beyond this 90-day period, it is expressly understood that with reasonable notice to the Contractor, the District may postpone issuing the Notice to Proceed.
 - b. It is further expressly understood by Contractor that Contractor shall not be entitled to any claim of additional compensation as a result of the postponement of the issuance of the Notice to Proceed beyond a 90-day period. If the Contractor believes that a postponement of issuance of the Notice to Proceed will cause a hardship to the Contractor, the Contractor may terminate the Contract. Contractor's termination due to a postponement beyond this 90-day period shall be by written notice to District within **TEN (10)** calendar days after receipt by Contractor of District's notice of postponement.

- c. It is further understood by the Contractor that in the event that Contractor terminates the Contract as a result of postponement by the District, the District shall only be obligated to pay Contractor for the Work that Contractor had performed at the time of notification of postponement and which the District had in writing authorized Contractor to perform prior to issuing a Notice to Proceed.
 - d. Should the Contractor terminate the Contract as a result of a notice of postponement, District shall have the authority to award the Contract to the next lowest responsive responsible bidder.
38. District reserves the right to reject any or all bids, including without limitation the right to reject any or all nonconforming, nonresponsive, unbalanced, or conditional bids, to re-bid, and to reject the bid of any bidder if District believes that it would not be in the best interest of the District to make an award to that bidder, whether because the bid is not responsive or the bidder is unqualified or of doubtful financial ability or fails to meet any other pertinent standard or criteria established by District. District also reserves the right to waive any inconsequential deviations or irregularities in any bid. For purposes of this paragraph, an "unbalanced bid" is one having nominal prices for some work items and/or enhanced prices for other work items.
39. It is the policy of the District that no qualified person shall be excluded from participating in, be denied the benefits of, or otherwise be subjected to discrimination in any consideration leading to the award of contract, based on race, color, gender, sexual orientation, political affiliation, age, ancestry, religion, marital status, national origin, medical condition or disability. The Successful Bidder and its subcontractors shall comply with applicable federal and state laws, including, but not limited to the California Fair Employment and Housing Act, beginning with Government Code section 12900, and Labor Code section 1735.
40. Prior to the award of Contract, District reserves the right to consider the responsibility of the Bidder. District may conduct investigations as District deems necessary to assist in the evaluation of any bid and to establish the responsibility, including, without limitation, qualifications and financial ability of Bidders, proposed subcontractors, suppliers, and other persons and organizations to perform and furnish the Work in accordance with the Contract Documents to District's satisfaction within the prescribed time.
41. Bidder expressly acknowledges that it is familiar with and capable of complying with applicable federal, State, and local requirements relating to COVID-19 or other public health emergency/epidemic/pandemic including, if required, preparing, posting, and implementing a Social Distancing Protocol, and such costs shall be included in the bid as an allowance. Any unused portion of the allowance designated for COVID-19 or other public health emergency/epidemic/pandemic compliance will revert back to the District documented by a deductive change order.

END OF DOCUMENT

BID FORM AND PROPOSAL

To: Governing Board of the Oxnard Union High School District ("District" or "Owner")

From: Luis Busso, Senior Project Geologist
(Proper Name of Bidder)

- 42. The undersigned declares that Bidder has read and understands the Contract Documents, including, without limitation, the Notice to Bidders and the Instructions to Bidders, and agrees and proposes to furnish all necessary labor, materials, and equipment to perform and furnish all work in accordance with the terms and conditions of the Contract Documents, including, without limitation, the Drawings and Specifications of the following project known as: **Bid 654 Rio Mesa High School Well No.2 Rehabilitation**

("Project" or "Contract") and will accept in full payment for that Work the following total lump sum amount, all taxes included:

| | | |
|---|---------|----------|
| _____ | dollars | \$ _____ |
| <i>TOTAL BASE BID FROM BID TABULATION SHEET TOTAL (bid tabulation sheet Exhibit A must be completed, or bid is deemed non-responsive)</i> | | |
| <i>Bidder acknowledges and agrees that the Base Bid accounts for any and all costs acknowledged and listed on the Bid Tabulation Sheet, Exhibit A.</i> | | |
| <i>\$2Million/\$5 Million Insurance Coverages will be required by OUHSD under its OCIP Program.</i> | | |

- 43. The undersigned has reviewed the Work outlined in the Contract Documents and fully understands the scope of Work required in this Proposal, understands the construction and project management function(s) is described in the Contract Documents, and that each Bidder who is awarded a contract shall be in fact a prime contractor, not a subcontractor, to the District, and agrees that its Proposal, if accepted by the District, will be the basis for the Bidder to enter into a contract with the District in accordance with the intent of the Contract Documents.
- 44. The undersigned has notified the District in writing of any discrepancies or omissions or of any doubt, questions, or ambiguities about the meaning of any of the Contract Documents and has contacted the Construction Manager before bid date to verify the issuance of any clarifying Addenda.
- 45. The undersigned agrees to commence work under this Contract on the date established in the Contract Documents and to complete all work within the time specified in the Contract Documents.
- 46. The liquidated damages clause of the General Conditions and Agreement is hereby acknowledged.

**Bid 654
Rio Mesa High School Well No.2
Rehabilitation
RMHS**

**OXNARD UNION HSD
DIVISION ZERO-17**

47. It is understood that the District reserves the right to reject this bid and that the bid shall remain open to acceptance and is irrevocable for a period of ninety (90) days.

48. The following documents are attached hereto:

- Hard Copy and Photocopy of Bid Bond/Bid Security on the District's form or other security (original due in hard copy by bid due date and time)
- Exhibit A Bid Tabulation Sheet
- Designated Subcontractors List
- Site Visit Certification
- Non-Collusion Declaration

49. Receipt and acceptance of the following Addenda is hereby acknowledged:

| | |
|---------------------------------------|------------------------|
| No. <u>1</u> , Dated <u>12/8/2021</u> | No. _____, Dated _____ |
| No. _____, Dated _____ | No. _____, Dated _____ |
| No. _____, Dated _____ | No. _____, Dated _____ |

50. Bidder acknowledges that the license required for performance of the Work is a **C-57** license.

51. Bidder hereby certifies that Bidder is able to furnish labor that can work in harmony with all other elements of labor employed or to be employed on the Work.

52. Bidder specifically acknowledges and understands that if it is awarded the Contract, that it shall perform the Work of the Project while complying with all requirements of the Department of Industrial Relations.

53. Bidder hereby certifies that its bid includes sufficient funds to permit Bidder to comply with all local, state or federal labor laws or regulations during the Project, including payment of prevailing wage, and that Bidder will comply with the provisions of Labor Code section 2810(d) if awarded the Contract

54. Bidder represents that it is competent, knowledgeable, and has special skills with respect to the nature, extent, and inherent conditions of the Work to be performed. Bidder further acknowledges that there are certain peculiar and inherent conditions existent in the construction of the Work that may create, during the Work, unusual or peculiar unsafe conditions hazardous to persons and property.

55. Bidder expressly acknowledges that it is aware of such peculiar risks and that it has the skill and experience to foresee and to adopt protective measures to perform the Work adequately and safely with respect to such hazards.

56. Bidder expressly acknowledges that it is familiar with and capable of complying with applicable federal, State, and local requirements relating to COVID-19 or other public

Bid 654
Rio Mesa High School Well No.2
Rehabilitation
RMHS

OXNARD UNION HSD
DIVISION ZERO-18

health emergency/epidemic/pandemic including, if required, preparing, posting, and implementing a Social Distancing Protocol.

57. Bidder expressly acknowledges that it is aware that if a false claim is knowingly submitted (as the terms "claim" and "knowingly" are defined in the California False Claims Act, Gov. Code, § 12650 et seq.), the District will be entitled to civil remedies set forth in the California False Claim Act. It may also be considered fraud and the Contractor may be subject to criminal prosecution.
58. The undersigned Bidder certifies that it is, at the time of bidding, and shall be throughout the period of the Contract, licensed by the State of California to do the type of work required under the terms of the Contract Documents and registered as a public works contractor with the Department of Industrial Relations. Bidder further certifies that it is regularly engaged in the general class and type of work called for in the Contract Documents.

Furthermore, Bidder hereby certifies to the District that all representations, certifications, and statements made by Bidder, as set forth in this bid form, are true and correct and are made under penalty of perjury.

Dated this 13th day of December 20 21

Name of Bidder: General Pump Company

Type of Organization: Corporation

Signature: 

Print Name: Luis Busso

Title: Senior Project Geologist

Address of Bidder: 934 West Verdulera Street

Taxpayer Identification No. of Bidder: 95-3551896

Telephone Number: (805) 482-1215

E-mail: Lbusso@genpump.com Web Page: www.genpump.com

Contractor's License No(s): No.: 496765 Class: C61/D21 Expiration Date: 08/31/2022

No.: _____ Class: _____ Expiration Date: _____

No.: _____ Class: _____ Expiration Date: _____

Public Works Contractor Registration No.: 1000002769

END OF DOCUMENT

Bid 654
Rio Mesa High School Well No.2
Rehabilitation
RMHS

OXNARD UNION HSD
DIVISION ZERO-19

BID BOND

(Note: If Bidder is providing a bid bond as its bid security, Bidder must use this form, NOT a surety company form.)

KNOW ALL PERSONS BY THESE PRESENTS:

That the undersigned, _____, as Principal ("Principal"), and _____, as Surety ("Surety"), a corporation organized and existing under and by virtue of the laws of the State of California and authorized to do business as a surety in the State of California, are held and firmly bound unto the Oxnard Union High School District ("District") of Ventura County, State of California, as Obligee, in an amount equal to ten percent (10%) of the Base Bid plus alternates, in the sum of

_____ Dollars (\$ _____)

lawful money of the United States of America, for the payment of which sum well and truly to be made, we, and each of us, bind ourselves, our heirs, executors, administrators, successors, and assigns, jointly and severally, firmly by these presents.

THE CONDITION OF THIS OBLIGATION IS SUCH that whereas the Principal has submitted a bid to the District for all Work specifically described in the accompanying bid for the following project: **Bid 654 RIO MESA HIGH SCHOOL WELL NO. 2 REHABILITATION** ("Project" or "Contract").

NOW, THEREFORE, if the Principal is awarded the Contract and, within the time and manner required under the Contract Documents, after the prescribed forms are presented to Principal for signature, enters into a written contract, in the prescribed form in accordance with the bid, and files two bonds, one guaranteeing faithful performance and the other guaranteeing payment for labor and materials as required by law, and meets all other conditions to the Contract between the Principal and the Obligee becoming effective, or if the Principal shall fully reimburse and save harmless the Obligee from any damage sustained by the Obligee through failure of the Principal to enter into the written contract and to file the required performance and labor and material bonds, and to meet all other conditions to the Contract between the Principal and the Obligee becoming effective, then this obligation shall be null and void; otherwise, it shall be and remain in full force and effect. The full payment of the sum stated above shall be due immediately if Principal fails to execute the Contract within ten (10) days of the date of the District's Notice of Award to Principal.

Surety, for value received, hereby stipulates and agrees that no change, extension of time, alteration or addition to the terms of the Contract or the call for bids, or to the work to be performed thereunder, or the specifications accompanying the same, shall in any way affect its obligation under this bond, and it does hereby waive notice of any such change, extension of time, alteration or addition to the terms of the Contract or the call for bids, or to the work, or to the specifications.

**Bid 654
Rio Mesa High School Well No.2
Rehabilitation
RMHS**

**OXNARD UNION HSD
DIVISION ZERO-20**

In the event suit is brought upon this bond by the Obligee and judgment is recovered, the Surety shall pay all costs incurred by the Obligee in such suit, including a reasonable attorneys' fee to be fixed by the Court.

If the District awards the bid, the security of unsuccessful bidder(s) shall be returned within sixty (60) days from the time the award is made. Unless otherwise required by law, no bidder may withdraw its bid for ninety (90) days after the date of the bid opening.

IN WITNESS WHEREOF, this instrument has been duly executed by the Principal and Surety above named, on the _____ day of _____, 20__.

Principal

By

Surety

By

Name of California Agent of Surety

Address of California Agent of Surety

Telephone Number of California Agent of Surety

Bidder must attach Power of Attorney and Certificate of Authority for Surety and a Notarial Acknowledgment for all Surety's signatures. The California Department of Insurance must authorize the Surety to be an admitted Surety Insurer.

END OF DOCUMENT

**Bid 654
Rio Mesa High School Well No.2
Rehabilitation
RMHS**

**OXNARD UNION HSD
DIVISION ZERO-21**

DESIGNATED SUBCONTRACTORS LIST
(Public Contact Code Sections 4100-4114)

Bidder acknowledges and agrees that it must clearly set forth below the name, location and California contractor license number of each subcontractor who will perform work or labor or render service to the Bidder in or about the construction of the Work or who will specially fabricate and install a portion of the Work according to detailed drawings contained in the plans and specifications in an amount in excess of one-half of one percent (0.5%) of Bidder's total Base Bid and the kind of Work that each will perform. Vendors or suppliers of materials only do not need to be listed.

Bidder acknowledges and agrees that, if Bidder fails to list as to any portion of Work, or if Bidder lists more than one subcontractor to perform the same portion of Work, Bidder must perform that portion itself or be subjected to penalty under applicable law. In case more than one subcontractor is named for the same kind of Work, state the portion of the kind of Work that each subcontractor will perform.

If alternate bid(s) is/are called for and Bidder intends to use subcontractors different from or in addition to those subcontractors listed for work under the Base Bid, Bidder must list subcontractors that will perform Work in an amount in excess of one half of one percent (0.5%) of Bidder's total Base Bid plus alternate(s).

If further space is required for the list of proposed subcontractors, attach additional copies of page 2 showing the required information, as indicated below.

Subcontractor Name: Ventura County Control System

CA Cont. Lic. #: N/A Location: Ventura, CA

DIR Registration #: pw-LR- 1000608665

Portion of Work: Electrical

Subcontractor Name: _____

CA Cont. Lic. #: _____ Location: _____

DIR Registration #: _____

Portion of Work: _____

Subcontractor Name: _____

CA Cont. Lic. #: _____ Location: _____

DIR Registration #: _____

Portion of Work: _____

Bid 654
Rio Mesa High School Well No.2
Rehabilitation
RMHS

OXNARD UNION HSD
DIVISION ZERO-22

Subcontractor Name: _____

CA Cont. Lic. #: _____ Location: _____

DIR Registration #: _____

Portion of Work: _____

Subcontractor Name: _____

CA Cont. Lic. #: _____ Location: _____

DIR Registration #: _____

Portion of Work: _____

Subcontractor Name: _____

CA Cont. Lic. #: _____ Location: _____

DIR Registration #: _____

Portion of Work: _____

Subcontractor Name: _____

CA Cont. Lic. #: _____ Location: _____

DIR Registration #: _____

Portion of Work: _____

Subcontractor Name: _____

CA Cont. Lic. #: _____ Location: _____

DIR Registration #: _____

Portion of Work: _____

Date: _____

Proper Name of Bidder: _____

Signature: _____

Print Name: _____

Title: _____

END OF DOCUMENT

**Bid 654
Rio Mesa High School Well No.2
Rehabilitation
RMHS**

**OXNARD UNION HSD
DIVISION ZERO-23**

SITE VISIT CERTIFICATION

Check option that applies:

X I certify that I visited the Site of the proposed Work, received the attached X pages of information and/or viewed the Bid Package on the District Website, and became fully acquainted with the conditions relating to construction and labor. I fully understand the facilities, difficulties, and restrictions attending the execution of the Work under contract.

X I certify that Luis Busso (Bidder's representative) visited the Site of the proposed Work, received the attached 77 pages of information and/or viewed the Bid Package on the District Website, and became fully acquainted with the conditions relating to construction and labor. The Bidder's representative fully understood the facilities, difficulties, and restrictions attending the execution of the Work under contract.

Bidder fully indemnifies the Oxnard Union High School District, its Architect, its Engineers, its Construction Manager, and all of their respective officers, agents, employees, and consultants from any damage, or omissions, related to conditions that could have been identified during my visit and/or the Bidder's representative's visit to the Site.

I certify under penalty of perjury under the laws of the State of California that the foregoing is true and correct.

Date: 12/13/2021

Proper Name of Bidder: General Pump Company

Signature: 

Print Name: Luis Busso

Title: Senior Project Geologist

END OF DOCUMENT

**NON-COLLUSION DECLARATION
(Public Contract Code Section 7106)**

The undersigned declares:

I am the Senior Project Geologist of General Pump Company, the party making the foregoing bid.
[Title] [Name of Firm]

The bid is not made in the interest of, or on behalf of, any undisclosed person, partnership, company, association, organization, or corporation. The bid is genuine and not collusive or sham. The bidder has not directly or indirectly induced or solicited any other bidder to put in a false or sham bid. The bidder has not directly or indirectly colluded, conspired, connived, or agreed with any bidder or anyone else to put in a sham bid, or to refrain from bidding. The bidder has not in any manner, directly or indirectly, sought by agreement, communication, or conference with anyone to fix the bid price of the bidder or any other bidder, or to fix any overhead, profit, or cost element of the bid price, or of that of any other bidder. All statements contained in the bid are true. The bidder has not, directly or indirectly, submitted his or her bid price or any breakdown thereof, or the contents thereof, or divulged information or data relative thereto, to any corporation, partnership, company, association, organization, bid depository, or to any member or agent thereof, to effectuate a collusive or sham bid, and has not paid, and will not pay, any person or entity for such purpose.

Any person executing this declaration on behalf of a bidder that is a corporation, partnership, joint venture, limited liability company, limited liability partnership, or any other entity, hereby represents that he or she has full power to execute, and does execute, this declaration on behalf of the bidder.

I declare under penalty of perjury under the laws of the State of California that the foregoing is true and correct and that this declaration is executed on 12/13/2021,
[Date]

at Camarillo, CA.
[City] [State]

Date: 12/13/2021

Proper Name of Bidder: General Pump Company

Signature: 

Print Name: Luis Busso

Title: Senior Project Geologist

END OF DOCUMENT

**Bid 654
Rio Mesa High School Well No.2
Rehabilitation
RMHS**

**OXNARD UNION HSD
DIVISION ZERO-25**

IRAN CONTRACTING ACT CERTIFICATION
(Public Contract Code Sections 2202-2208)

Prior to bidding on or submitting a proposal for a contract for goods or services of \$1,000,000 or more, the bidder/proposer must submit this certification pursuant to Public Contract Code section 2204.

The bidder/proposer must complete **ONLY ONE** of the following two options. To complete OPTION 1, check the corresponding box **and** complete the certification below. To complete OPTION 2, check the corresponding box, complete the certification below, and attach documentation demonstrating the exemption approval.

- OPTION 1.** Bidder/Proposer is not on the current list of persons engaged in investment activities in Iran created by the California Department of General Services ("DGS") pursuant to Public Contract Code section 2203(b), and we are not a financial institution extending twenty million dollars (\$20,000,000) or more in credit to another person, for 45 days or more, if that other person will use the credit to provide goods or services in the energy sector in Iran and is identified on the current list of persons engaged in investment activities in Iran created by DGS.
- OPTION 2.** Bidder/Proposer has received a written exemption from the certification requirement pursuant to Public Contract Code sections 2203(c) and (d). *A copy of the written documentation demonstrating the exemption approval is included with our bid/proposal.*

CERTIFICATION:

I, the official named below, CERTIFY UNDER PENALTY OF PERJURY, that I am duly authorized to legally bind the bidder/proposer to the OPTION selected above. This certification is made under the laws of the State of California.

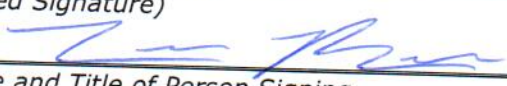
| | |
|---|----------------------------|
| Vendor Name/Financial Institution (Printed) | Federal ID Number (or n/a) |
| General Pump Company | N/A |
| By (Authorized Signature) | |
|  | |
| Printed Name and Title of Person Signing | Date Executed |
| Luis Busso, Senior Project Geologist | 12/13/2021 |

END OF DOCUMENT

Bid 654
Rio Mesa High School Well No.2
Rehabilitation
RMHS

OXNARD UNION HSD
DIVISION ZERO-26

WORKERS' COMPENSATION CERTIFICATION

Labor Code section 3700, in relevant part, provides:

Every employer except the State shall secure the payment of compensation in one or more of the following ways:

- a. By being insured against liability to pay compensation by one or more insurers duly authorized to write compensation insurance in this state; and/or
- b. By securing from the Director of Industrial Relations a certificate of consent to self-insure, which may be given upon furnishing proof satisfactory to the Director of Industrial Relations of ability to self-insure and to pay any compensation that may become due to his employees.

I am aware of the provisions of section 3700 of the Labor Code which require every employer to be insured against liability for workers' compensation or to undertake self-insurance in accordance with the provisions of that code, and I will comply with such provisions before commencing the performance of the Work of this Contract.

Date: 12/13/2021

Proper Name of Contractor: General Pump Company

Signature: 

Print Name: Luis Busso

Title: Senior Project Geologist

(In accordance with Labor Code sections 1860 and 1861, the above certificate must be signed and filed with the awarding body prior to performing any Work under this Contract.)

END OF DOCUMENT

**PREVAILING WAGE AND
RELATED LABOR REQUIREMENTS CERTIFICATION**

I hereby certify that I will conform to the State of California Public Works Contract requirements regarding prevailing wages, benefits, on-site audits with 48-hours' notice, payroll records, and apprentice and trainee employment requirements, for all Work on the above Project including, without limitation, labor compliance monitoring and enforcement by the Department of Industrial Relations.

[IF THIS PROJECT USES FEDERAL FUNDS, DISTRICT SHOULD INCLUDE THE FOLLOWING] I hereby certify that I will also conform to the Federal Labor Standards Provisions regarding minimum wages, withholding, payrolls and basic records, apprentice and trainee employment requirements, equal employment opportunity requirements, Copeland Act requirements, Davis-Bacon and Related Act requirements, Contract Work Hours and Safety Standards Act requirements, and any and all other applicable requirements for federal funding for all Work on the above Project.

Date: 12/13/2021

Proper Name of Contractor: General Pump Company

Signature: 

Print Name: Luis Busso

Title: Senior Project Geologist

END OF DOCUMENT

**DISABLED VETERAN BUSINESS
ENTERPRISE PARTICIPATION CERTIFICATION**

GENERAL INSTRUCTIONS

Section 17076.11 of the Education Code requires school districts using, or planning to use, funds allocated pursuant to the State of California School Facility Program ("Program") for the construction and/or modernization of school buildings to have a participation goal for disabled veteran business enterprises ("DVBE") of at least three percent (3%) per year of the overall dollar amount expended each year by the school district on projects that receive state funding. Therefore, the lowest responsive responsible Bidder awarded the Contract must submit this document to the District with its executed Agreement, identifying the steps contractor took to solicit DVBE participation in conjunction with this Contract. **Submit this form no later than four (4) calendar days after bid opening.**

PART I – Method of Compliance with DVBE Participation Goals. Check the appropriate box to indicate your method of committing the contract dollar amount.

| YOUR BUSINESS ENTERPRISE IS: | AND YOU WILL | AND YOU WILL |
|---|---|---|
| A. <input type="checkbox"/> Disabled veteran owned and your forces will perform at least 3% of this Contract | Include a copy of your DVBE letter from Office of Small Business and Disabled Veterans Business Enterprise Services ("OSDS")* | Complete Part 1 of this form and the Certification |
| B. <input type="checkbox"/> Disabled veteran owned but is unable to perform 3% of this Contract with your forces | Use DVBE subcontractors /suppliers to bring the Contract participation to at least 3% | Include a copy of each DVBE's letter from OSDS (including yours, if applicable), and complete Part 1 of this form and the Certification |
| C. <input type="checkbox"/> NOT disabled veteran owned | Use DVBE subcontractors /suppliers for at least 3% of this Contract | |
| D. <input type="checkbox"/> Unable to meet the required participation goals after good faith efforts | Make good faith efforts, including contacts, advertisement and DVBE solicitation | Complete all of this form and the Certification |

* A DVBE letter from OSDS is obtained from the participating DVBE.

**Bid 654
Rio Mesa High School Well No.2
Rehabilitation
RMHS**

**OXNARD UNION HSD
DIVISION ZERO-29**

You must complete the following table to show the dollar amount of DVBE participation:

| | TOTAL CONTRACT PRICE |
|---|-----------------------------|
| A. Prime Bidder, if DVBE (own participation) | \$ |
| B. DVBE Subcontractor or Supplier | |
| 1. | |
| 2. | |
| 3. | |
| 4. | |
| C. Subtotal (A & B) | |
| D. Non-DVBE | |
| E. Total Bid | |

PART II – Contacts. To identify DVBE subcontractors/suppliers for participation in your contract, you must contact each of the following categories. You should contact several DVBE organizations.

| CATEGORY | TELEPHONE NUMBER | DATE CONTACTED | PERSON CONTACTED |
|---|-------------------------|-----------------------|-------------------------|
| 1. The District, if any | | | * |
| 2. OSDS, provides assistance locating DVBEs at https://caleprocure.ca.gov/pages/PublicSearch/supplier-search.aspx | (916) 375-4940 | | * |
| 3. DVBE Organization (List) | | | * |
| | | | |
| | | | |
| | | | |

*Write "recorded message" in this column, if applicable.

**Bid 654
Rio Mesa High School Well No.2
Rehabilitation
RMHS**

**OXNARD UNION HSD
DIVISION ZERO-30**

PART III – Advertisement. You must advertise for DVBE participation in both a trade and focus paper. List the advertisement you place to solicit DVBE participation. Advertisements should be published at least fourteen (14) days prior to bid/proposal opening; if you cannot advertise fourteen (14) days prior, advertisements should be published as soon as possible. Advertisements must include that your firm is seeking DVBE participation, the project name and location, and your firm’s name, your contact person, and telephone number. Attach copies of advertisements to this form.

| FOCUS/TRADE PAPER NAME | CHECK ONE | | DATE OF ADVERTISEMENT |
|------------------------|-----------|-------|-----------------------|
| | TRADE | FOCUS | |
| | | | |
| | | | |

PART IV – DVBE Solicitations. List DVBE subcontractors/suppliers that were invited to bid. Use the following instructions to complete the remainder of this section (read the three columns as a sentence from left to right). If you need additional space to list DVBE solicitations, please use a separate page and attach to this form.

| IF THE DVBE..... | THEN..... | AND..... | | |
|--|--------------------------------------|--|---------------------|-------------|
| was selected to participate | Check "YES" in the "SELECTED" column | include a copy of their DVBE letter(s) from OSDS | | |
| was NOT selected to participate | Check "NO" in the "SELECTED" column | state why in the "REASON NOT SELECTED" column | | |
| did not respond to your solicitation | Check the "NO RESPONSE" column. | | | |
| DVBE CONTACTED | SELECTED | | REASON NOT SELECTED | NO RESPONSE |
| | YES | NO | | |
| | | | | |
| | | | | |
| | | | | |
| | | | | |

A copy of this form must be retained by you and may be subject to a future audit.

CERTIFICATION

I, Luis Busso, certify that I am the bidder's Senior Project Geologist and that I have made a diligent effort to ascertain the facts with regard to the representations made herein. In making this certification, I am aware of section 12650 et seq. of the Government Code providing for the imposition of treble damages for making false claims.

Date: 12/13/2021

Proper Name of Contractor: General Pump Company

Signature: 

Print Name: Luis Busso

Title: Senior Project Geologist

END OF DOCUMENT

DRUG-FREE WORKPLACE CERTIFICATION

This Drug-Free Workplace Certification form is required from the successful Bidder pursuant to Government Code section 8350 et seq., the Drug-Free Workplace Act of 1990. The Drug-Free Workplace Act of 1990 requires that every person or organization awarded a contract or grant for the procurement of any property or service from any state agency must certify that it will provide a drug-free workplace by doing certain specified acts. In addition, the Act provides that each contract or grant awarded by a state agency may be subject to suspension of payments or termination of the contract or grant, and the contractor or grantee may be subject to debarment from future contracting, if the contracting agency determines that specified acts have occurred.

The District is not a "state agency" as defined in the applicable section(s) of the Government Code, but the District is a local agency and public school district under California law and requires all contractors on District projects to comply with the provisions and requirements of the Drug-Free Workplace Act of 1990.

Contractor must also comply with the provisions of Health & Safety Code section 11362.3 which prohibits the consumption or possession of cannabis or cannabis products in any public place, including school grounds, and specifically on school grounds while children are present.

Contractor shall certify that it will provide a drug-free workplace by doing all of the following:

- a. Publishing a statement notifying employees that the unlawful manufacture, distribution, dispensation, possession, or use of a controlled substance is prohibited in the person's or organization's workplace and specifying actions which will be taken against employees for violations of the prohibition.
- b. Establishing a drug-free awareness program to inform employees about all of the following:
 - (1) The dangers of drug abuse in the workplace.
 - (2) The person's or organization's policy of maintaining a drug-free workplace.
 - (3) The availability of drug counseling, rehabilitation, and employee-assistance programs.
 - (4) The penalties that may be imposed upon employees for drug abuse violations.
- c. Requiring that each employee engaged in the performance of the contract or grant be given a copy of the statement required above, and that, as a condition of employment on the contract or grant, the employee agrees to abide by the terms of the statement.

**Bid 654
Rio Mesa High School Well No.2
Rehabilitation
RMHS**

**OXNARD UNION HSD
DIVISION ZERO-33**

I, the undersigned, agree to fulfill the terms and requirements of Government Code section 8355 listed above and will publish a statement notifying employees concerning (a) the prohibition of controlled substance at the workplace, (b) establishing a drug-free awareness program, and (c) requiring that each employee engaged in the performance of the Contract be given a copy of the statement required by section 8355(a), and requiring that the employee agree to abide by the terms of that statement.

I also understand that if the District determines that I have either (a) made a false certification herein, or (b) violated this certification by failing to carry out the requirements of section 8355, that the Contract awarded herein is subject to termination, suspension of payments, or both. I further understand that, should I violate the terms of the Drug-Free Workplace Act of 1990, I may be subject to debarment in accordance with the requirements of the aforementioned Act.

I acknowledge that I am aware of the provisions of and hereby certify that I will adhere to the requirements of the Drug-Free Workplace Act of 1990 and Health and Safety Code section 11362.3.

Date: 12/13/2021

Proper Name of Contractor: General Pump Company

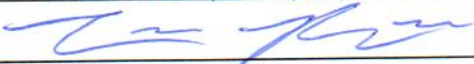
Signature: 

Print Name: Luis Busso

Title: Senior Project Geologist

END OF DOCUMENT

TOBACCO-FREE ENVIRONMENT CERTIFICATION

This Tobacco-Free Environment Certification form is required from the successful Bidder.

Pursuant to, without limitation, 20 U.S.C. section 6083, Labor Code section 6400 et seq., Health & Safety Code section 104350 et seq., Business and Professions Code section 22950 et seq., and District Board policies, all District sites, including the Project site, are tobacco-free environments. Smoking and the use of tobacco products by all persons is prohibited on or in District property. District property includes school buildings, school grounds, school-owned vehicles and vehicles owned by others while on District property. The prohibition on smoking includes the use of any electronic smoking device that creates an aerosol or vapor, in any manner or in any form, and the use of any oral smoking device for the purpose of circumventing the prohibition of tobacco smoking. Further, Health & Safety Code section 11362.3 prohibits the smoking or use of cannabis or cannabis products in any place where smoking tobacco is prohibited.

I acknowledge that I am aware of the District's policy regarding tobacco-free environments at District sites, including the Project site and hereby certify that I will adhere to the requirements of that policy and not permit any of my firm's employees, agents, subcontractors, or my firm's subcontractors' employees or agents, to use tobacco and/or smoke on the Project site.

Date: 12/13/2021

Proper Name of Contractor: General Pump Company

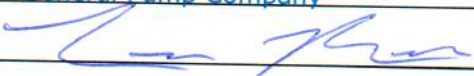
Signature: 

Print Name: Luis Busso

Title: Senior Project Geologist

END OF DOCUMENT

HAZARDOUS MATERIALS CERTIFICATION

1. Contractor hereby certifies that no asbestos, or asbestos-containing materials, polychlorinated biphenyl (PCB), or any material listed by the federal or state Environmental Protection Agency or federal or state health agencies as a hazardous material, or any other material defined as being hazardous under federal or state laws, rules, or regulations, ("New Hazardous Material"), shall be furnished, installed, or incorporated in any way into the Project or in any tools, devices, clothing, or equipment used to affect any portion of Contractor's work on the Project for District.
2. Contractor further certifies that it has instructed its employees with respect to the above-mentioned standards, hazards, risks, and liabilities.
3. Asbestos and/or asbestos-containing material shall be defined as all items containing but not limited to chrysotile, crocidolite, amosite, anthophyllite, tremolite, and actinolite. Any or all material containing greater than one-tenth of one percent (0.1%) asbestos shall be defined as asbestos-containing material.
4. Any disputes involving the question of whether or not material is New Hazardous Material shall be settled by electron microscopy or other appropriate and recognized testing procedure, at the District's determination. The costs of any such tests shall be paid by Contractor if the material is found to be New Hazardous Material.
5. All Work or materials found to be New Hazardous Material or Work or material installed with equipment containing New Hazardous Material will be immediately rejected and this Work will be removed at Contractor's expense at no additional cost to the District.
6. Contractor has read and understood the document titled Hazardous Materials Procedures & Requirements, and shall comply with all the provisions outlined therein.

Date: 12/13/2021

Proper Name of Contractor: General Pump Company

Signature: 

Print Name: Luis Busso

Title: Senior Project Geologist

END OF DOCUMENT

LEAD-BASED MATERIALS CERTIFICATION

This certification provides notice to the Contractor that:

- (1) Contractor's work may disturb lead-containing building materials.
- (2) Contractor shall notify the District if any work may result in the disturbance of lead-containing building materials.
- (3) Contractor shall comply with the Renovation, Repair and Painting Rule, if lead-based paint is disturbed in a six-square-foot or greater area indoors or a 20-square-foot or greater area outdoors.

1. Lead as a Health Hazard

Lead poisoning is recognized as a serious environmental health hazard facing children today. Even at low levels of exposure, much lower than previously believed, lead can impair the development of a child's central nervous system, causing learning disabilities, and leading to serious behavioral problems. Lead enters the environment as tiny lead particles and lead dust disburse when paint chips, chalks, peels, wears away over time, or is otherwise disturbed. Ingestion of lead dust is the most common pathway of childhood poisoning; lead dust gets on a child's hands and toys and then into a child's mouth through common hand-to-mouth activity. Exposures may result from construction or remodeling activities that disturb lead paint, from ordinary wear and tear of windows and doors, or from friction on other surfaces.

Ordinary construction and renovation or repainting activities carried out without lead-safe work practices can disturb lead-based paint and create significant hazards. Improper removal practices, such as dry scraping, sanding, or water blasting painted surfaces, are likely to generate high volumes of lead dust.

Because the Contractor and its employees will be providing services for the District, and because the Contractor's work may disturb lead-containing building materials, **CONTRACTOR IS HEREBY NOTIFIED** of the potential presence of lead-containing materials located within certain buildings utilized by the District. All school buildings built prior to 1978 are presumed to contain some lead-based paint until sampling proves otherwise.

2. Overview of California Law

Education Code section 32240 et seq. is known as the Lead-Safe Schools Protection Act. Under this act, the Department of Health Services is to conduct a sample survey of schools in the State of California for the purpose of developing risk factors to predict lead contamination in public schools. (Ed. Code, § 32241.)

Any school that undertakes any action to abate existing risk factors for lead is required to utilize trained and state-certified contractors, inspectors, and workers.

**Bid 654
Rio Mesa High School Well No.2
Rehabilitation
RMHS**

**OXNARD UNION HSD
DIVISION ZERO-37**

(Ed. Code, § 32243, subd. (b).) Moreover, lead-based paint, lead plumbing, and solders, or other potential sources of lead contamination, shall not be utilized in the construction of any new school facility or the modernization or renovation of any existing school facility. (Ed. Code, § 32244.)

Both the Federal Occupational Safety and Health Administration ("Fed/OSHA") and the California Division of Occupational Safety and Health ("Cal/OSHA") have implemented safety orders applicable to all construction work where a contractor's employee may be occupationally exposed to lead.

The OSHA Regulations apply to all construction work where a contractor's employee may be occupationally exposed to lead. The OSHA Regulations contain specific and detailed requirements imposed on contractors subject to those regulations. The OSHA Regulations define construction work as work for construction, alteration, and/or repair, including painting and decorating. Regulated work includes, but is not limited to, the following:

- a. Demolition or salvage of structures where lead or materials containing lead are present;
- b. Removal or encapsulation of materials containing lead;
- c. New construction, alteration, repair, or renovation of structures, substrates, or portions thereof, that contain lead, or materials containing lead;
- d. Installation of products containing lead;
- e. Lead contamination/emergency cleanup;
- f. Transportation, disposal, storage, or containment of lead or materials containing lead on the site or location at which construction activities are performed; and
- g. Maintenance operations associated with the construction activities described in the subsection.

Because it is assumed by the District that all painted surfaces (interior as well as exterior) within the District contain some level of lead, it is imperative that the Contractor, its workers and subcontractors fully and adequately comply with all applicable laws, rules and regulations governing lead-based materials (including title 8, California Code of Regulations, section 1532.1).

Contractor shall notify the District if any Work may result in the disturbance of lead-containing building materials. Any and all Work that may result in the disturbance of lead-containing building materials shall be coordinated through the District. A signed copy of this Certification shall be on file prior to beginning Work on the Project, along with all current insurance certificates.

3. Renovation, Repair and Painting Rule, Section 402(c)(3) of the Toxic Substances Control Act

The EPA requires lead safe work practices to reduce exposure to lead hazards created by renovation, repair and painting activities that disturb lead-based paint. Pursuant to the Renovation, Repair and Painting Rule (RRP), renovations in homes, childcare facilities, and schools built prior to 1978 must be conducted by certified renovations firms, using renovators with training by a EPA-accredited training provider, and fully and adequately complying with all applicable laws, rules and regulations governing lead-based materials, including those rules and regulations appearing within title 40 of the Code of Federal Regulations as part 745 (40 CFR 745).

The RRP requirements apply to all contractors who disturb lead-based paint in a six-square-foot or greater area indoors or a 20-square-foot or greater area outdoors. If a DPH-certified inspector or risk assessor determines that a home constructed before 1978 is lead-free, the federal certification is not required for anyone working on that particular building.

4. Contractor's Liability

If the Contractor fails to comply with any applicable laws, rules, or regulations, and that failure results in a site or worker contamination, the Contractor will be held solely responsible for all costs involved in any required corrective actions, and shall defend, indemnify, and hold harmless the District, pursuant to the indemnification provisions of the Contract, for all damages and other claims arising therefrom.

If lead disturbance is anticipated in the Work, only persons with appropriate accreditation, registrations, licenses, and training shall conduct this Work.

It shall be the responsibility of the Contractor to properly dispose of any and all waste products, including, but not limited to, paint chips, any collected residue, or any other visual material that may occur from the prepping of any painted surface. It will be the responsibility of the Contractor to provide the proper disposal of any hazardous waste by a certified hazardous waste hauler. This company shall be registered with the Department of Transportation (DOT) and shall be able to issue a current manifest number upon transporting any hazardous material from any school site within the District.

The Contractor shall provide the District with any sample results prior to beginning Work, during the Work, and after the completion of the Work. The District may request to examine, prior to the commencement of the Work, the lead training records of each employee of the Contractor.

THE CONTRACTOR HEREBY ACKNOWLEDGES, UNDER PENALTY OF PERJURY, THAT IT:

1. HAS RECEIVED NOTIFICATION OF POTENTIAL LEAD-BASED MATERIALS ON THE OWNER'S PROPERTY;
2. IS KNOWLEDGEABLE REGARDING AND WILL COMPLY WITH ALL APPLICABLE LAWS, RULES, AND REGULATIONS GOVERNING WORK WITH, AND DISPOSAL, OF LEAD.

Bid 654
Rio Mesa High School Well No.2
Rehabilitation
RMHS

OXNARD UNION HSD
DIVISION ZERO-39

THE UNDERSIGNED WARRANTS THAT HE/SHE HAS THE AUTHORITY TO SIGN ON BEHALF OF AND BIND THE CONTRACTOR. THE DISTRICT MAY REQUIRE PROOF OF SUCH AUTHORITY.

Date: 12/13/2021

Proper Name of Contractor: General Pump Company

Signature: 

Print Name: Luis Busso

Title: Senior Project Geologist

END OF DOCUMENT

IMPORTED MATERIALS CERTIFICATION

This form shall be executed by all entities that, in any way, provide or deliver and/or supply any soils, aggregate, or related materials ("Fill") to the Project Site and shall be provided to the District at least ten (10) days before delivery. All Fill shall satisfy all requirements of any environmental review of the Project performed pursuant to the statutes and guidelines of the California Environmental Quality Act, section 21000 et seq. of the Public Resources Code ("CEQA"), and all requirements of section 17210 et seq. of the Education Code, including requirements for a Phase I environmental assessment acceptable to the State of California Department of Education and Department of Toxic Substances Control.

Certification of: Delivery Firm/Transporter Supplier Manufacturer
 Wholesaler Broker Retailer
 Distributor Other Contractor

Type of Entity Corporation General Partnership
 Limited Partnership Limited Liability Company
 Sole Proprietorship Other _____

Name of firm ("Firm"): General Pump Co.

Mailing address: 159 N. Acacia, San Dimas, CA

Addresses of branch office used for this Project: _____

By my signature below, I hereby certify that I am aware of section 25260 of the Health and Safety Code and the sections referenced therein regarding the definition of hazardous material. I further certify on behalf of the Firm that all soils, aggregates, or related materials provided, delivered, and/or supplied or that will be provided, delivered, and/or supplied by this Firm to the Project Site are free of any and all hazardous material as defined in section 25260 of the Health and Safety Code. I further certify that I am authorized to make this certification on behalf of the Firm.

Date: 12/13/2021

Proper Name of Firm: General Pump Company

Signature: 

Print Name: Luis Busso

Title: Senior Project Geologist

END OF DOCUMENT

CRIMINAL BACKGROUND INVESTIGATION
/FINGERPRINTING CERTIFICATION

The undersigned does hereby certify to the governing board of the District as follows:

That I am a representative of the Contractor currently under contract with the District; that I am familiar with the facts herein certified; and that I am authorized and qualified to execute this certificate on behalf of Contractor.

Contractor certifies that it has taken at least one of the following actions with respect to the construction Project that is the subject of the Contract (check all that apply):

- The Contractor is a sole proprietor and intends to comply with the fingerprinting requirements of Education Code section 45125.1(k) with respect to all Contractor's employees who may have contact with District pupils in the course of providing services pursuant to the Contract, and hereby agrees to the District's preparation and submission of fingerprints such that the California Department of Justice may determine that none of those employees has been convicted of a felony, as that term is defined in Education Code section 45122.1. No work shall commence until such determination by DOJ has been made.
- The Contractor, who is not a sole proprietor, has complied with the fingerprinting requirements of Education Code section 45125.1 with respect to all Contractor's employees and all of its Subcontractors' employees who may have contact with District pupils in the course of providing services pursuant to the Contract, and the California Department of Justice has determined that none of those employees has been convicted of a felony, as that term is defined in Education Code section 45122.1. A complete and accurate list of Contractor's employees and of all of its subcontractors' employees who may come in contact with District pupils during the course and scope of the Contract is attached hereto; and/or
- Pursuant to Education Code section 45125.2, Contractor has installed or will install, prior to commencement of Work, a physical barrier at the Work Site, that will limit contact between Contractor's employees and District pupils at all times;

Contractor's responsibility for background clearance extends to all of its employees, Subcontractors, and employees of Subcontractors coming into contact with District pupils regardless of whether they are designated as employees or acting as independent contractors of the Contractor.

Date: 12/14/2021
Proper Name of Contractor: General Pump Company
Signature: 
Print Name: Luis Busso
Title: Senior Project Geologist

END OF DOCUMENT

BUY AMERICAN CERTIFICATION

Federal regulations require that all of the iron, steel, and manufactured goods used in projects for the construction, installation, repairs, renovation, modernization, or maintenance of a public building or public work funded in part or in whole by federal stimulus funds, with the exception of projects funded by Qualified School Construction Bonds, be produced in the United States of America, unless a federal department waives this requirement because (1) it is inconsistent with the public interest, (2) the goods are not produced in sufficient quantities or of satisfactory quality in the United States, or (3) the requirement would increase the cost of the Project overall by more than twenty-five percent (25%) ("Buy American").

Contractor shall submit this Certification with its executed agreement, identifying the steps Contractor will take to use goods produced in the United States of America in carrying out this Contract. Bidder should not submit this form with its bid.

Contractor shall retain a copy of this form and may be subject to a future audit.

CERTIFICATION

On behalf of Contractor, I represent and covenant that Contractor will use on the Project only iron, steel and manufactured goods produced in the United States of America except goods for which a federal department has waived this requirement.

I, Luis Busso, certify that I am the Contractor's Senior Project Geologist and that the representations and covenants made herein are true and correct. In making this certification, I am aware of section 12650 et seq. of the Government Code providing for the imposition of treble damages for making false claims.

Date: 12/13/2021
Proper Name of Contractor: General Pump Company
Signature: 
Print Name: Luis Busso
Title: Senior Project Geologist

END OF DOCUMENT

that I am aware of section 3000 et seq. of the California Public Contract Code, and the sections referenced therein regarding the penalties for providing false information or failing to disclose a financial relationship in this disclosure. I further certify that I am authorized to make this certification on behalf of the Firm.

Date: _____

Proper Name of Firm: _____

Signature: _____

Print Name: _____

Title: _____

END OF DOCUMENT

N/A

DOCUMENT 00 45 49

REGISTERED SUBCONTRACTORS LIST
(Labor Code Section 1771.1)

Contractor acknowledges and agrees that it must clearly set forth below the name and Department of Industrial Relations (DIR) registration number of each subcontractor **for all tiers** who will perform work or labor or render service to Contractor or its subcontractors in or about the construction of the Work **at least two (2) weeks before the subcontractor is scheduled to perform work.** This document is to be updated as all tiers of subcontractors are identified.

Contractor acknowledges and agrees that, if Contractor fails to list as to any subcontractor of any tier who performs any portion of Work, the Contract is subject to cancellation and the Contractor will be subjected to penalty under applicable law.

If further space is required for the list of proposed subcontractors, attach additional copies of page 2 showing the required information, as indicated below.

Subcontractor Name: _____

DIR Registration #: _____

Portion of Work: _____

Subcontractor Name: _____

DIR Registration #: _____

Portion of Work: _____

Subcontractor Name: _____

DIR Registration #: _____

Portion of Work: _____

Subcontractor Name: _____

DIR Registration #: _____

Portion of Work: _____

Subcontractor Name: _____

DIR Registration #: _____

Portion of Work: _____

Bid 654
Rio Mesa High School Well No.2
Rehabilitation
RMHS

OXNARD UNION HSD
DIVISION ZERO-46

Subcontractor Name: _____

DIR Registration #: _____

Portion of Work: _____

Subcontractor Name: _____

DIR Registration #: _____

Portion of Work: _____

Subcontractor Name: _____

DIR Registration #: _____

Portion of Work: _____

Subcontractor Name: _____

DIR Registration #: _____

Portion of Work: _____

Subcontractor Name: _____

DIR Registration #: _____

Portion of Work: _____

Subcontractor Name: _____

DIR Registration #: _____

Portion of Work: _____

Date: 12/13/2021

Name of Contractor: General Pump Company

Signature: _____

Print Name: Luis Busso

Title: Senior Project Geologist

END OF DOCUMENT

DOCUMENT 00 51 00

NOTICE OF AWARD

Dated: _____ 20__

To: _____ (Contractor)

To: _____
(Address)

From: Governing Board ("Board") of the Oxnard Union High School District ("District")

Re: **Bid 654 RIO MESA HIGH SCHOOL WELL NO. 2 REHABILITATION** ("Project").

Contractor has been awarded the Contract for the above-referenced Project on _____, 20__, by action of the District's Board.

The Contract Price is _____ Dollars (\$_____).

You must comply with the following conditions precedent within **TEN (10)** calendar days of the date of this Notice of Award.

The Contractor shall execute and submit the following documents by 5:00 p.m. of the **TEN (th)** calendar day following the date of the Notice of Award.

- a. Agreement: To be executed by successful Bidder. Submit three (3) copies, each bearing an original signature.
- b. Performance Bond (100%): On the form provided in the Contract Documents and fully executed as indicated on the form.
- c. Payment Bond (Contractor's Labor & Material Bond) (100%): On the form provided in the Contract Documents and fully executed as indicated on the form.
- d. Insurance Certificates and Endorsements as required.
- e. Workers' Compensation Certification.
- f. Prevailing Wage and Related Labor Requirements Certification.
- g. Drug-Free Workplace Certification.
- h. Tobacco-Free Environment Certification.
- i. Hazardous Materials Certification.

**Bid 654
Rio Mesa High School Well No.2
Rehabilitation
RMHS**

**OXNARD UNION HSD
DIVISION ZERO-48**

j. Criminal Background Investigation/Fingerprinting Certification.

Failure to comply with these conditions within the time specified will entitle District to consider your bid abandoned, to annul this Notice of Award, and to declare your Bid Security forfeited, as well as any other rights the District may have against the Contractor.

After you comply with those conditions, District will return to you one fully signed counterpart of the Agreement.

OXNARD UNION HIGH SCHOOL DISTRICT

BY: _____

NAME: _____

TITLE: _____

END OF DOCUMENT

AGREEMENT

THIS AGREEMENT IS MADE AND ENTERED INTO THIS _____ DAY OF _____
_____, 20____, by and between the Oxnard Union High School District ("District") and _____

("Contractor")
("Agreement").

WITNESSETH: That the parties hereto have mutually covenanted and agreed, and by these presents do covenant and agree with each other, as follows:

1. **The Work:** Contractor agrees to furnish all tools, equipment, apparatus, facilities, labor, and material necessary to perform and complete in a good and workmanlike manner, the work of the following project:

Bid 654 RIO MESA HIGH SCHOOL WELL NO.2 REHABILITATION
("Project" or "Contract" or "Work")

It is understood and agreed that the Work shall be performed and completed as required in the Contract Documents including, without limitation, the Drawings and Specifications and submission of all documents required to secure funding or by the Division of the State Architect for close-out of the Project, under the direction and supervision of, and subject to the approval of, the District or its authorized representative.

2. **The Contract Documents:** The complete Contract consists of all Contract Documents as defined in the General Conditions and incorporated herein by this reference. Any and all obligations of the District and Contractor are fully set forth and described in the Contract Documents. All Contract Documents are intended to cooperate so that any Work called for in one and not mentioned in the other or vice versa is to be executed the same as if mentioned in all Contract Documents.
3. **Interpretation of Contract Documents:** Should any question arise concerning the intent or meaning of Contract Documents, including the Drawings or Specifications, the question shall be submitted to the District for interpretation. If a conflict exists in the Contract Documents, valid, written modifications, beginning with the most recent, shall control over this Agreement (if any), which shall control over the Special Conditions, which shall control over any Supplemental Conditions, which shall control over the General Conditions, which shall control over the remaining Division 0 documents, which shall control over Division 1 Documents which shall control over Division 2 through Division 49 documents, which shall control over figured dimensions, which shall control over large-scale drawings, which shall control over small-scale drawings. In the case of a discrepancy or ambiguity solely between and among the Drawings and Specifications, the discrepancy or ambiguity shall be resolved in favor of the interpretation that will provide District with the functionally complete and operable Project described in the Drawings and Specifications. In no case shall a document calling for lower quality and/or quantity material or workmanship control. The decision of the District in the matter shall be final.

**Bid 654
Rio Mesa High School Well No.2
Rehabilitation
RMHS**

**OXNARD UNION HSD
DIVISION ZERO-50**

4. **Time for Completion:** It is hereby understood and agreed that the Work under this Contract shall be completed by April 1, 2022 or as specified in the District's Notice to Proceed.
5. **Completion - Extension of Time:** Should the Contractor fail to complete this Contract, and the Work provided herein, within the time fixed for completion, due allowance being made for the contingencies provided for herein, the Contractor shall become liable to the District for all loss and damage that the District may suffer on account thereof. The Contractor shall coordinate its Work with the Work of all other contractors. The District shall not be liable for delays resulting from Contractor's failure to coordinate its Work with other contractors in a manner that will allow timely completion of Contractor's Work. Contractor shall be liable for delays to other contractors caused by Contractor's failure to coordinate its Work with the Work of other contractors.
6. **Liquidated Damages:** Time is of the essence for all work under this Agreement. It is hereby understood and agreed that it is and will be difficult and/or impossible to ascertain and determine the actual damage that the District will sustain in the event of and by reason of Contractor's delay; therefore, Contractor agrees that it shall pay to the District the sum of **One Thousand dollars (\$1,000.00)** per day as liquidated damages for each and every day's delay beyond the time herein prescribed in finishing the Work.

It is hereby understood and agreed that this amount is not a penalty.

In the event that any portion of the liquidated damages is not paid to the District, the District may deduct that amount from any money due or that may become due the Contractor under this Agreement, and such deduction does not constitute a withholding or penalty. The District's right to assess liquidated damages is as indicated herein and in the General Conditions.

The time during which the Contract is delayed for cause, as hereinafter specified, may extend the time of completion for a reasonable time as the District may grant, provided that Contractor has complied with the claims procedure of the Contract Documents. This provision does not exclude the recovery of damages by either party under other provisions in the Contract Documents.

7. **Loss Or Damage:** The District and its agents and authorized representatives shall not in any way or manner be answerable or suffer loss, damage, expense, or liability for any loss or damage that may happen to the Work, or any part thereof, or in or about the same during its construction and before acceptance, and the Contractor shall assume all liabilities of every kind or nature arising from the Work, either by accident, negligence, theft, vandalism, or any cause whatsoever; and shall hold the District and its agents and authorized representatives harmless from all liability of every kind and nature arising from accident, negligence, or any cause whatsoever.
8. **Limitation Of District Liability:** District's financial obligations under this Contract shall be limited to the payment of the compensation provided in this Contract. Notwithstanding any other provision of this Contract, in no event shall District be liable, regardless of whether any claim is based on contract or tort, for any special, consequential, indirect or incidental damages, including, but not limited to, lost

profits or revenue, lost bonding capacity, arising out of or in connection with this Contract for the services performed in connection with this Contract.

9. **Insurance and Bonds:** Contractor and all Subcontractors under the Contractor shall participate in and comply with the owner-controlled or wrap-up insurance program ("OCIP"). Prior to issuance of the Notice to Proceed by the District, Contractor shall provide all required certificates of insurance and insurance endorsements, except for those coverages provided by the OCIP as described in the OCIP Manual, and payment and performance bonds as evidence thereof.
10. **Prosecution of Work:** If the Contractor should neglect to prosecute the Work properly or fail to perform any provisions of this Contract, the District, may, pursuant to the General Conditions and without prejudice to any other remedy it may have, make good such deficiencies and may deduct the cost thereof from the payment then or thereafter due the Contractor.
11. **Authority of Architect, Project Inspector, and DSA:** Contractor hereby acknowledges that the Architect(s), the Project Inspector(s), and the Division of the State Architect ("DSA") have authority to approve and/or suspend Work if the Contractor's Work does not comply with the requirements of the Contract Documents, Title 24 of the California Code of Regulations, and all applicable laws and regulations. The Contractor shall be liable for any delay caused by its non-compliant Work.
12. **Assignment of Contract:** Neither the Contract, nor any part thereof, nor any moneys due or to become due thereunder, may be assigned by the Contractor without the prior written approval of the District, nor without the written consent of the Surety on the Contractor's Performance Bond (the "Surety"), unless the Surety has waived in writing its right to notice of assignment.
13. **Classification of Contractor's License:** Contractor hereby acknowledges that it currently holds valid Type **C-57** Contractor's license(s) issued by the State of California, Contractors' State License Board, in accordance with division 3, chapter 9, of the Business and Professions Code and in the classification called for in the Contract Documents.
14. **Registration as Public Works Contractor:** The Contractor and all Subcontractors currently are registered as public works contractors with the Department of Industrial Relations, State of California, in accordance with Labor Code section 1771.1.
15. **Payment of Prevailing Wages:** The Contractor and all Subcontractors shall pay all workers on all Work performed pursuant to this Contract not less than the general prevailing rate of per diem wages and the general prevailing rate for holiday and overtime work as determined by the Director of the Department of Industrial Relations, State of California, for the type of work performed and the locality in which the work is to be performed within the boundaries of the District, pursuant to sections 1770 et seq. of the California Labor Code.
16. **Labor Compliance Monitoring and Enforcement:** This Project is subject to labor compliance monitoring and enforcement by the Department of Industrial Relations

**Bid 654
Rio Mesa High School Well No.2
Rehabilitation
RMHS**

**OXNARD UNION HSD
DIVISION ZERO-52**

pursuant to Labor Code section 1771.4 and Title 8 of the California Code of Regulations. Contractor specifically acknowledges and understands that it shall perform the Work of this Agreement while complying with all the applicable provisions of Division 2, Part 7, Chapter 1, of the Labor Code, including, without limitation, the requirement that the Contractor and all of its Subcontractors shall timely submit complete and accurate electronic certified payroll records as required by the Contract Documents, or the District may not issue payment.

17. **Contract Price:** In consideration of the foregoing covenants, promises, and agreements on the part of the Contractor, and the strict and literal fulfillment of each and every covenant, promise, and agreement, and as compensation agreed upon for the Work and construction, erection, and completion as aforesaid, the District covenants, promises, and agrees that it will well and truly pay and cause to be paid to the Contractor in full, and as the full Contract Price and compensation for construction, erection, and completion of the Work hereinabove agreed to be performed by the Contractor, the following price:

_____ Dollars
(\$ _____),

in lawful money of the United States, which sum is to be paid according to the schedule provided by the Contractor and accepted by the District and subject to additions and deductions as provided in the Contract. This amount supersedes any previously stated and/or agreed to amount(s).

18. **No Representations:** No representations have been made other than as set forth in writing in the Contract Documents, including this Agreement. Each of the Parties to this Agreement warrants that it has carefully read and understood the terms and conditions of this Agreement and all Contract Documents, and that it has not relied upon the representations or advice of any other Party or any attorney not its own.
19. **Entire Agreement:** The Contract Documents, including this Agreement, set forth the entire agreement between the parties hereto and fully supersede any and all prior agreements, understandings, written or oral, between the parties hereto pertaining to the subject matter thereof.
20. **Severability:** If any term, covenant, condition, or provision in any of the Contract Documents is held by a court of competent jurisdiction to be invalid, void or unenforceable, the remainder of the provisions in the Contract Documents shall remain in full force and effect and shall in no way be affected, impaired, or invalidated thereby.
21. **Authority of Signatories:** Each party has the full power and authority to enter into and perform this Contract, and the person signing this Contract on behalf of each party has been properly authorized and empowered to enter into this Contract. This Contract may be executed in one or more counterparts, each of which shall be deemed an original. For this Agreement, and for all Contract Documents requiring a signature, a facsimile or electronic signature shall be deemed to be the equivalent of the actual original signature. All counterparts so executed shall constitute one Contract binding all the Parties hereto.

**Bid 654
Rio Mesa High School Well No.2
Rehabilitation
RMHS**

**OXNARD UNION HSD
DIVISION ZERO-53**

[SIGNATURES ON FOLLOWING PAGE]

IN WITNESS WHEREOF, accepted and agreed on the date indicated above:

[CONTRACTOR NAME]

OXNARD UNION HIGH SCHOOL DISTRICT

General Pump Company

By: Luis Busso

By: _____

Title: Senior Project Geologist

Title: _____

NOTE: If the party executing this Contract is a corporation, a certified copy of the by-laws, or of the resolution of the Board of Directors, authorizing the officers of said corporation to execute the Contract and the bonds required thereby must be attached hereto.

END OF DOCUMENT

DOCUMENT 00 55 00

NOTICE TO PROCEED

Dated: _____, 20__

TO: _____
("Contractor")

ADDRESS: _____

PROJECT: **Bid 654 RIO MESA HIGH SCHOOL WELL NO.2 REHABILITATION**
("Contract")

You are notified that the Contract Time under the above Contract will commence to run on _____, 20__. By that date, you are to start performing your obligations under the Contract Documents. In accordance with the Agreement executed by Contractor, the date of completion is **APRIL 1, 2022.**

You must submit the following documents by 5:00 p.m. of the TENTH (10th) calendar day following the date of this Notice to Proceed:

- a. Contractor's preliminary schedule of construction.
- b. Contractor's preliminary schedule of values for all of the Work.
- c. Contractor's preliminary schedule of submittals, including Shop Drawings, Product Data, and Samples submittals
- d. Contractor's Safety Plan specifically adapted for the Project.
- e. Registered Subcontractors List: A complete subcontractors list for all tiers, including the name, address, telephone number, email address, facsimile number, California State Contractors License number, license classification, Department of Industrial Relations registration number, and monetary value of all Subcontracts.

Thank you. We look forward to a very successful Project.

OXNARD UNION HIGH SCHOOL DISTRICT

BY: _____

NAME: _____

TITLE: _____

END OF DOCUMENT

**Bid 654
Rio Mesa High School Well No.2
Rehabilitation
RMHS**

**OXNARD UNION HSD
DIVISION ZERO-55**

PERFORMANCE BOND
(100% of Contract Price)

(Note: Contractor must use this form, NOT a surety company form.)

KNOW ALL PERSONS BY THESE PRESENTS:

WHEREAS, the governing board ("Board") of the Oxnard Union High School District, ("District") and _____ ("Principal") have entered into a contract for the furnishing of all materials and labor, services and transportation, necessary, convenient, and proper to perform the following project:

Bid 654 RIO MESA HIGH SCHOOL WELL NO.2 REHABILITATION

("Project" or "Contract") which Contract dated _____, 20____, and all of the Contract Documents attached to or forming a part of the Contract, are hereby referred to and made a part hereof; and WHEREAS, said Principal is required under the terms of the Contract to furnish a bond for the faithful performance of the Contract.

NOW, THEREFORE, the Principal and _____ ("Surety") are held and firmly bound unto the Board of the District in the penal sum of _____

Dollars (\$_____), lawful money of the United States, for the payment of which sum well and truly to be made we bind ourselves, our heirs, executors, administrators, successors, and assigns jointly and severally, firmly by these presents, to:

- Promptly perform all the work required to complete the Project; and
- Pay to the District all damages the District incurs as a result of the Principal's failure to perform all the Work required to complete the Project.

Or, at the District's sole discretion and election, the Surety shall obtain a bid or bids for completing the Contract in accordance with its terms and conditions, and upon determination by the District of the lowest responsible bidder, arrange for a contract between such bidder and the District and make available as Work progresses sufficient funds to pay the cost of completion less the "balance of the Contract Price," and to pay and perform all obligations of Principals under the Contract, including, without limitation, all obligations with respect to warranties, guarantees and the payment of liquidated damages. The term "balance of the Contract Price," as used in this paragraph, shall mean the total amount payable to Principal by the District under the Contract and any modifications thereto, less the amount previously paid by the District to the Principal, less any withholdings by the District allowed under the Contract. District shall not be required or obligated to accept a tender of a completion contractor from the Surety for any or no reason.

The condition of the obligation is such that, if the above bound Principal, its heirs, executors, administrators, successors, or assigns, shall in all things stand to and abide by, and well and truly keep and perform the covenants, conditions, and agreements in the Contract and any alteration

Bid 654
Rio Mesa High School Well No.2
Rehabilitation
RMHS

OXNARD UNION HSD
DIVISION ZERO-56

thereof made as therein provided, on its part to be kept and performed at the time and in the intent and meaning, including all contractual guarantees and warranties of materials and workmanship, and shall indemnify and save harmless the District, its trustees, officers and agents, as therein stipulated, then this obligation shall become null and void, otherwise it shall be and remain in full force and virtue.

Surety expressly agrees that the District may reject any contractor or subcontractor proposed by Surety to fulfill its obligations in the event of default by the Principal. Surety shall not utilize Principal in completing the Work nor shall Surety accept a Bid from Principal for completion of the Work if the District declares the Principal to be in default and notifies Surety of the District's objection to Principal's further participation in the completion of the Work.

As a condition precedent to the satisfactory completion of the Contract, the above obligation shall hold good for a period equal to the warranty and/or guarantee period of the Contract, during which time Surety's obligation shall continue if Contractor shall fail to make full, complete, and satisfactory repair and replacements and totally protect the District from loss or damage resulting from or caused by defective materials or faulty workmanship. The obligations of Surety hereunder shall continue so long as any obligation of Contractor remains. Nothing herein shall limit the District's rights or the Contractor or Surety's obligations under the Contract, law or equity, including, but not limited to, California Code of Civil Procedure section 337.15.

The Surety, for value received, hereby stipulates and agrees that no change, extension of time, alteration, or addition to the terms of the contract or to the work to be performed thereunder or the specifications accompanying the same shall in any way affect its obligation on this bond. The Surety also stipulates and agrees that it shall not be exonerated or released from the obligation of this bond by any overpayment or underpayment by the District that is based upon estimates approved by the Architect. The Surety does hereby waive notice of any such change, extension of time, alteration, or addition to the terms of the Contract or to the work or to the specifications.

IN WITNESS WHEREOF, two (2) identical counterparts of this instrument, each of which shall for all purposes be deemed an original thereof, have been duly executed by the Principal and Surety above named, on the _____ day of _____, 20____.

| | |
|--------------------|--|
| _____ Principal | _____ Surety |
| _____ By | _____ By |
| | _____ Name of California Agent of Surety |
| | _____ Address of California Agent of Surety |
| | _____ Telephone No. of California Agent of Surety |

Contractor must attach a Notarial Acknowledgment for all Surety's signatures and a Power of Attorney and Certificate of Authority for Surety. The California Department of Insurance must authorize the Surety to be an admitted surety insurer.

**Bid 654
Rio Mesa High School Well No.2
Rehabilitation
RMHS**

**OXNARD UNION HSD
DIVISION ZERO-57**

END OF DOCUMENT

DOCUMENT 00 61 13.16

PAYMENT BOND
Contractor's Labor & Material Bond
(100% Of Contract Price)

(Note: Contractor must use this form, NOT a surety company form.)

KNOW ALL PERSONS BY THESE PRESENTS:

WHEREAS, the governing board ("Board") of the Oxnard Union High School District, ("District") and _____, ("Principal") have entered into a contract for the furnishing of all materials and labor, services and transportation, necessary, convenient, and proper to perform the following project:

Bid 654 RIO MESA HIGH SCHOOL WELL NO.2 REHABILITATION

("Project" or "Contract") which Contract dated _____, 20____, and all of the Contract Documents attached to or forming a part of the Contract, are hereby referred to and made a part hereof; and

WHEREAS, pursuant to law and the Contract, the Principal is required, before entering upon the performance of the work, to file a good and sufficient bond with the body by which the Contract is awarded in an amount equal to one hundred percent (100%) of the Contract price, to secure the claims to which reference is made in sections 9000 through 9510 and 9550 through 9566 of the Civil Code, and division 2, part 7, of the Labor Code.

NOW, THEREFORE, the Principal and _____ ("Surety") are held and firmly bound unto all laborers, material men, and other persons referred to in said statutes in the sum of _____ Dollars (\$ _____), lawful money of the United States, being a sum not less than the total amount payable by the terms of Contract, for the payment of which sum well and truly to be made, we bind ourselves, our heirs, executors, administrators, successors, or assigns, jointly and severally, by these presents.

The condition of this obligation is that if the Principal or any of its subcontractors, or their heirs, executors, administrators, successors, or assigns of any, all, or either of them shall fail to pay for any labor, materials, provisions, or other supplies, used in, upon, for or about the performance of the work contracted to be done, or for any work or labor thereon of any kind, or for amounts required to be deducted, withheld, and paid over to the Employment Development Department from the wages of employees of the Principal or any of his or its subcontractors of any tier under Section 13020 of the Unemployment Insurance Code with respect to such work or labor, that the Surety will pay the same in an amount not exceeding the amount herein above set forth, and also in case suit is brought upon this bond, will pay a reasonable attorney's fee to be awarded and fixed by the court, and to be taxed as costs and to be included in the judgment therein rendered.

Bid 654
Rio Mesa High School Well No.2
Rehabilitation
RMHS

OXNARD UNION HSD
DIVISION ZERO-58

It is hereby expressly stipulated and agreed that this bond shall inure to the benefit of any and all persons, companies, and corporations entitled to file claims under section 9100 of the Civil Code, so as to give a right of action to them or their assigns in any suit brought upon this bond.

Should the condition of this bond be fully performed, then this obligation shall become null and void; otherwise it shall be and remain in full force and affect.

And the Surety, for value received, hereby stipulates and agrees that no change, extension of time, alteration, or addition to the terms of Contract or the specifications accompanying the same shall in any manner affect its obligations on this bond, and it does hereby waive notice of any such change, extension, alteration, or addition.

IN WITNESS WHEREOF, two (2) identical counterparts of this instrument, each of which shall for all purposes be deemed an original thereof, have been duly executed by the Principal and Surety above named, on the _____ day of _____, 20__.

| | |
|--------------------|--|
| _____ Principal | _____ Surety |
| _____ By | _____ By |
| | _____ Name of California Agent of Surety |
| | _____ Address of California Agent of Surety |
| | _____ Telephone No. of California Agent of Surety |

Contractor must attach a Notarial Acknowledgment for all Surety's signatures and a Power of Attorney and Certificate of Authority for Surety. The California Department of Insurance must authorize the Surety to be an admitted surety insurer.

END OF DOCUMENT

**Bid 654
Rio Mesa High School Well No.2
Rehabilitation
RMHS**

**OXNARD UNION HSD
DIVISION ZERO-59**

PROPOSED CHANGE ORDER FORM

Oxnard Union High School District
 309 South K Street
 Oxnard, CA 93030

| |
|-----------------|
| PCO NO.: |
| |

Project: _____
Bid No.: _____
RFI #: _____

Date: _____
DSA File No.: _____
DSA Appl. No.: _____

Contractor hereby submits for District’s review and evaluation this Proposed Change Order (“PCO”), submitted in accordance with and subject to the terms of the Contract Documents, including Sections 17.7 and 17.8 of the General Conditions. Any spaces left blank below are deemed no change to cost or time.

Contractor understands and acknowledges that documentation supporting Contractor’s PCO must be attached and included for District review and evaluation. Contractor further understands and acknowledges that failure to include documentation sufficient to, in District’s discretion, support some or all of the PCO, shall result in a rejected PCO.

| | <u>WORK PERFORMED OTHER THAN BY CONTRACTOR</u> | <u>ADD</u> | <u>DEDUCT</u> |
|-----|--|-------------------|---------------------------|
| (a) | <u>Material</u> (attach suppliers’ invoice or itemized quantity and unit cost plus sales tax) | | |
| (b) | <u>Add Labor</u> (attach itemized hours and rates, fully Burdened, and specify the hourly rate for each additional labor burden, for example, payroll taxes, fringe benefits, etc.) | | |
| (c) | <u>Add Equipment</u> (attach suppliers’ invoice) | | |
| (d) | <u>Subtotal</u> | | |
| (e) | <u>Add overhead and profit for any and all tiers of Subcontractor</u> , the total not to exceed ten percent (10%) of Item (d) | | |
| (f) | <u>Subtotal</u> | | |
| (g) | <u>Add General Conditions</u> (if Time is Compensable) (attach supporting documentation) | | |
| (h) | <u>Subtotal</u> | | |
| (i) | <u>Add Overhead and Profit for Contractor</u> , not to exceed five percent (5%) of Item (h) | | |
| (j) | <u>Subtotal</u> | | |
| (k) | <u>Add Bond and Insurance</u> , not to exceed two percent (2%) of Item (j) | | |
| (l) | <u>TOTAL</u> | | |
| (m) | <u>Time</u> (zero unless indicated; “TBD” not permitted) | | ____ Calendar Days |

[REMAINDER OF PAGE LEFT BLANK INTENTIONALLY]

Bid 654
Rio Mesa High School Well No.2
Rehabilitation
RMHS

OXNARD UNION HSD
DIVISION ZERO-60

| | WORK PERFORMED BY CONTRACTOR | ADD | DEDUCT |
|-----|---|------------|-----------------------|
| (a) | Material (attach itemized quantity and unit cost plus sales tax) | | |
| (b) | Add Labor (attach itemized hours and rates, fully Burdened, and specify the hourly rate for each additional labor burden, for example, payroll taxes, fringe benefits, etc.) | | |
| (c) | Add Equipment (attach suppliers' invoice) | | |
| (d) | Add General Conditions (if Time is Compensable) (attach supporting documentation) | | |
| (e) | Subtotal | | |
| (f) | Add Overhead and Profit for Contractor , not to exceed fifteen percent (15%) of Item (e) | | |
| (g) | Subtotal | | |
| (h) | Add Bond and Insurance , not to exceed two percent (2%) of Item (g) | | |
| (i) | TOTAL | | |
| (j) | Time (zero unless indicated; "TBD" not permitted) | | ____ Calendar Days |

The undersigned Contractor approves the foregoing as to the changes, if any, to the Contract Price specified for each item, and as to the extension of time allowed, if any, for completion of the entire Work as stated herein, and agrees to furnish all labor, materials, and service, and perform all work necessary to complete any additional work specified for the consideration stated herein. Submission of sums which have no basis in fact or which Contractor knows are false are at the sole risk of Contractor and may be a violation of the False Claims Act set forth under Government Code section 12650 et seq. It is understood that the changes herein to the Contract shall only be effective when approved by the governing board of the District.

It is expressly understood that the value of the extra Work or changes expressly includes any and all of the Contractor's costs and expenses, direct and indirect, resulting from additional time required on the Project or resulting from delay to the Project including, without limitation, cumulative impacts. Contractor is not entitled to separately recover amounts for overhead or other indirect costs. Any costs, expenses, damages, or time extensions not included are deemed waived.

SUBMITTED BY:

Contractor:

[Name]

Date

END OF DOCUMENT

**Bid 654
Rio Mesa High School Well No.2
Rehabilitation
RMHS**

**OXNARD UNION HSD
DIVISION ZERO-61**

GUARANTEE FORM

_____ ("Contractor") hereby agrees that the _____
_____ ("Work" of Contractor) which Contractor has installed for the Oxnard Union
High School District ("District") for the following project:

PROJECT: Bid 654 RIO MESA HIGH SCHOOL WELL NO.2 REHABILITATION

("Project" or "Contract") has been performed in accordance with the requirements of the
Contract Documents and that the Work as installed will fulfill the requirements of the
Contract Documents.

The undersigned agrees to repair or replace any or all of such Work that may prove to be
defective in workmanship or material together with any other adjacent Work that may be
displaced in connection with such replacement within a period of **TWO (2)_year(s)** from
the date of completion as defined in Public Contract Code section 7107, subdivision (c),
ordinary wear and tear and unusual abuse or neglect excepted. The date of completion is
_____, 20____.

In the event of the undersigned's failure to comply with the above-mentioned conditions
within a reasonable period of time, as determined by the District, but not later than seven
(7) days after being notified in writing by the District, the undersigned authorizes the
District to proceed to have said defects repaired and made good at the expense of the
undersigned. The undersigned shall pay the costs and charges therefor upon demand.

Date: _____

Proper Name of Contractor: _____

Signature: _____

Print Name: _____

Title: _____

Representatives to be contacted for service subject to terms of Contract:

Name: _____

Address: _____

Phone No.: _____

Email: _____

END OF DOCUMENT

**Bid 654
Rio Mesa High School Well No.2
Rehabilitation
RMHS**

**OXNARD UNION HSD
DIVISION ZERO-62**

SPECIAL CONDITIONS

1. Modernization Projects

- **Access. Access to the school buildings and entry to buildings, classrooms, restrooms, mechanical rooms, electrical rooms, or other rooms, for construction purposes, must be coordinated with District and onsite District personnel before Work is to start. Unless agreed to otherwise in writing, only a school custodian will be allowed to unlock and lock doors in existing building(s). The custodian will be available only while school is in session. If a custodian is required to arrive before 7:00 a.m. or leave after 3:30 p.m. to accommodate Contractor's Work, the overtime wages for the custodian will be paid by the Contractor, unless at the discretion of the District, other arrangements are made in advance.**
- **Keys. Upon request, the District may, at its own discretion, provide keys to the school site for the convenience of the Contractor. The Contractor agrees to pay all expenses to re-key the entire school site and all other affected District buildings if the keys are lost or stolen, or if any unauthorized party obtains a copy of the key or access to the school.**
- **Maintaining Services. The Contractor is advised that Work is to be performed in spaces regularly scheduled for instruction. Interruption and/or periods of shutdown of public access, electrical service, water service, lighting, or other utilities shall be only as arranged in advance with the District. Contractor shall provide temporary services to all facilities interrupted by Contractor's Work.**
- **Maintaining Utilities. The Contractor shall maintain in operation during duration of Contract, drainage lines, storm drains, sewers, water, gas, electrical, steam, and other utility service lines within working area.**
- **Confidentiality. Contractor shall maintain the confidentiality of all information, documents, programs, procedures and all other items that Contractor encounters while performing the Work. This requirement shall be ongoing and shall survive the expiration or termination of this Contract and specifically includes, without limitation, all student, parent, and employee disciplinary information and health information.**
- **Work during Instructional Time. By submitting its bid, Contractor affirms that Work may be performed during ongoing instruction in existing facilities. If so, Contractor agrees to cooperate to the best of its ability to minimize any disruption to school operations and any use**

of school facilities by the public up to, and including, rescheduling specific work activities, at no additional cost to District.

- **No Work during Student Testing. Contractor shall, at no additional cost to the District and at the District's request, coordinate its Work to not disturb District students including, without limitation, not performing any Work when students at the Site are taking State or Federally-required tests.**

2. Badge Policy for Contractors

All Contractors doing work for the District will provide their workers with identification badges. These badges will be worn by all members of the Contractor's staff who are working in a District facility.

- **Badges must be filled out in full and contain the following information:**
 - 2.1.1** Name of Contractor
 - 2.1.2** Name of Employee
 - 2.1.3** Contractor's address and phone number
- **Badges are to be worn when the Contractor or his/her employees are on site and must be visible at all times. Contractors must inform their employees that they are required to allow District employees, the Architect, the Construction Manager, the Program Manager, or the Project Inspector to review the information on the badges upon request.**
- **Continued failure to display identification badges as required by this policy may result in the individual being removed from the Project or assessment of fines against the Contractor.**

3. Federal Funds

As this Project is funded in whole or in part by federal funds, Contractor and all Subcontractors are subject to civil or criminal prosecution for any violation of the federal False Claims Act set forth under section 1001 of title 18 and section 231 of title 31 of the United States Code.

The following provisions are added as Section 27 of the General Conditions:

- **FEDERAL LABOR, WAGE & HOUR, APPRENTICE, AND RELATED PROVISIONS**

- **Minimum Wages**

The Davis-Bacon Act and 29 CFR parts 1 through 7 shall apply if the Project is financed in whole or in part from Federal funds or in accordance with guarantees of a Federal

agency or financed from funds obtained by pledge of any contract of a Federal agency to make a loan, grant or annual contribution.

3.1.1 All laborers and mechanics employed or working upon the Site of the Work (or under the United States Housing Act of 1937 or under the Housing Act of 1949 in the construction or development of the Project), will be paid unconditionally and not less often than once a week, and without subsequent deduction or rebate on any account, except such payroll deductions as are permitted by regulations issued by the Secretary of Labor under the Copeland Act (29 CFR part 3) , the full amount of wages and bona fide fringe benefits, or cash equivalents thereof, due at time of payment computed at rates not less than those contained in the applicable wage determination of the Secretary of Labor regardless of any contractual relationship which may be alleged to exist between the Contractor and such laborers and mechanics.

Contributions made or costs reasonably anticipated for bona fide fringe benefits under section 1(b)(2) of the Davis-Bacon Act on behalf of laborers or mechanics are considered wages paid to such laborers or mechanics, subject to the provisions of this section, including but not limited to paragraph 27.1.7; also, regular contributions made or costs incurred for more than a weekly period, but not less often than quarterly, under plans, funds, or programs which cover the particular weekly period, are deemed to be constructively made or incurred during such weekly period. Such laborers and mechanics shall be paid the appropriate wage rate and fringe benefits on the wage determination for the classification of Work actually performed, without regard to skill, except as provided in 29 CFR 5.5(a)(4). Laborers or mechanics performing Work in more than one classification may be compensated at the rate specified for each classification for the time actually worked therein: Provided, that the employer's payroll records accurately set forth the time spent in each classification in which Work is performed. The wage determination including any additional classification and wage rates conformed under this section, including but not limited to paragraph 27.1.6 and the Davis-Bacon poster (WH-1321) shall be posted at all times by the Contractor and its Subcontractors at the Site of the Work in a prominent and accessible place where it can be easily seen by the workers.

3.1.2 Any class of laborers or mechanics, including helpers, and which is to be employed under the Contract which is not listed in the wage determination shall be classified in conformance with the wage determination. An additional classification and wage rate and fringe benefits will not be approved unless when the following criteria have been met:

- The Work to be performed by the classification requested is not performed by a classification in the wage determination; and

3.1.2.1 The classification is utilized in the area by the construction industry; and

3.1.2.2 The proposed wage rate, including any bona fide fringe benefits, bears a reasonable relationship to the wage rates contained in the wage determination.

3.1.3 If the Contractor and the laborers and mechanics to be employed in the classification (if known), or their representatives, and the District agree on the

Bid 654
Rio Mesa High School Well No.2
Rehabilitation
RMHS

OXNARD UNION HSD
DIVISION ZERO-65

classification and wage rate (including the amount designated for fringe benefits where appropriate), a report of the action taken shall be sent by the Contractor to the Administrator of the Wage and Hour Division, Employment Standards Administration, U.S. Department of Labor, Washington, DC 20210.

3.1.4 In the event the Contractor, the laborers or mechanics to be employed in the classification or their representatives, and the District do not agree on the proposed classification and wage rate (including the amount designated for fringe benefits, where appropriate), the Contractor shall provide the questions, including the views of all interested parties and the recommendation of the District, to the District for the District's review and referral to the Administrator for determination.

3.1.5 The wage rate (including fringe benefits where appropriate) determined pursuant to this section, shall be paid to all workers performing Work in the classification under this Contract from the first day on which Work is performed in the classification.

3.1.6 Whenever the minimum wage rate prescribed in any applicable wage determination for a class of laborers or mechanics includes a fringe benefit which is not expressed as an hourly rate, Contractor shall either pay the benefit as stated in the wage determination or shall pay another bona fide fringe benefit or an hourly cash equivalent thereof.

3.1.7 If the Contractor does not make payments to a trustee or other third person, the Contractor may consider, as part of the wages of any laborer or mechanic, the amount of any costs reasonably anticipated in providing bona fide fringe benefits under a plan or program, provided that the Secretary of Labor has found, upon the written request of the Contractor, that the applicable standards of the Davis-Bacon Act have been met. If the Secretary of Labor so requires, the Contractor shall set aside in a separate account sufficient assets to meet obligations under the plan or program.

3.2 Withholding. District may, upon its own action or upon written request of an authorized representative of the Department of Labor, withhold or cause to be withheld from the Contractor under this Contract or any other Federal contract with the same Contractor, or any other federally-assisted contract subject to Davis-Bacon prevailing wage requirements, which is held by the same Contractor, so much of the accrued payments or advances as may be considered necessary to pay laborers and mechanics, including apprentices, trainees, and helpers, employed by the Contractor or any Subcontractor the full amount of wages required by the Contract. In the event of Contractor's or any Subcontractors' failure to pay any laborer or mechanic, including any apprentice, trainee, or helper, employed or working on the Site of the Work (or under the United States Housing Act of 1937 or under the Housing Act of 1949 in the construction or development of the project), all or part of the wages required by the Contract, the District may, after written notice to the Contractor, sponsor, applicant, or owner, take such action as it deems necessary to cause the suspension of any

further payment, advance, or guarantee of funds until such violations have ceased.

3.3 Payrolls and basic records.

3.3.1 Payrolls and basic records relating thereto shall be maintained by the Contractor during the course of the Work and preserved for a period of three years thereafter for all laborers and mechanics working at the Site of the Work (or under the United States Housing Act of 1937, or under the Housing Act of 1949, in the construction or development of the project). Such records shall contain the name, address, and social security number of each worker, his or her correct classification, hourly rates of wages paid (including rates of contributions or costs anticipated for bona fide fringe benefits or cash equivalents thereof of the types described in section 1(b)(2)(B) of the Davis-Bacon Act), daily and weekly number of hours worked, deductions made and actual wages paid. Whenever the Secretary of Labor has found under 29 CFR 5.5(a)(1)(iv) that the wages of any laborer or mechanic include the amount of any costs reasonably anticipated in providing benefits under a plan or program described in section 1(b)(2)(B) of the Davis-Bacon Act, the Contractor shall maintain records that show that the commitment to provide such benefits is enforceable, that the plan or program is financially responsible, and that the plan or program has been communicated in writing to the laborers or mechanics affected, and records which show the costs anticipated or the actual cost incurred in providing such benefits. Contractors employing apprentices or trainees under approved programs shall maintain written evidence of the registration of apprenticeship programs and certification of trainee programs, the registration of the apprentices and trainees, and the ratios and wage rates prescribed in the applicable programs.

3.3.2 The Contractor shall submit weekly for each week in which any Contract Work is performed a copy of all payrolls to the District. The payrolls submitted shall set out accurately and completely all of the information required to be maintained under 29 CFR 5.5(a)(3)(i), except that full social security numbers and home addresses shall not be included on weekly transmittals. Instead the payrolls shall only need to include an individually identifying number for each employee (e.g., the last four digits of the employee's social security number). The required weekly payroll information shall be submitted on a form acceptable to the District. Optional Form WH-347 is available for this purpose from the Wage and Hour Division Web site at <https://www.dol.gov/whd/programs/dbra/wh347.htm> or its successor site. Contractor is responsible for the submission of copies of payrolls by all Subcontractors. Contractor and Subcontractors shall maintain the full social security number and current address of each covered worker, and shall provide them upon request to the District, the Contractor, or the Wage and Hour Division of the Department of Labor for purposes of an investigation or audit of compliance with prevailing wage requirements. Contractor may require a Subcontractor to provide addresses and social security numbers to the Contractor for its own records, without weekly submission to the District or other government agency

3.3.3 Each payroll submitted shall be accompanied by a "Statement of Compliance," signed by the Contractor or Subcontractor or his or her agent who pays or supervises the payment of the persons employed under the Contract and shall certify the following:

3.3.3.1 That the payroll for the payroll period contains the information required to be provided under 29 CFR 5.5 (a)(3)(ii) of Regulations, 29 CFR part 5,

3.3.3.2 That the appropriate information is being maintained under 29 CFR 5.5 (a)(3)(i) of Regulations, 29 CFR part 5, and

3.3.3.3 That such information is correct and complete;

3.3.3.4 That each laborer or mechanic (including each helper, apprentice, and trainee) employed on the Contract during the payroll period has been paid the full weekly wages earned, without rebate, either directly or indirectly, and

3.3.3.5 That no deductions have been made either directly or indirectly from the full wages earned, other than permissible deductions as set forth in Regulations, 29 CFR part 3;

3.3.3.6 That each laborer or mechanic has been paid not less than the applicable wage rates and fringe benefits or cash equivalents for the classification of Work performed, as specified in the applicable wage determination incorporated into or applicable to the Contract.

3.3.3.7 The weekly submission of a properly executed certification in the form set forth on the reverse side of Optional Form WH-347 shall satisfy the requirement for submission of the "Statement of Compliance" required by paragraph 27.3.3 of this section.

3.3.3.8 The falsification of any of the above certifications may subject the Contractor or one or more Subcontractors to civil or criminal prosecution under section 1001 of title 18 and section 231 of title 31 of the United States Code.

3.3.3.9 The Contractor or Subcontractor shall make the records required under this section available for inspection, copying, or transcription by authorized representatives of the District or the federal Department of Labor, and shall permit representatives to interview employees during working hours on the job. If the Contractor or Subcontractor fails to submit the required records or to make them available, the Federal agency may, after written notice to the Contractor, sponsor, applicant, or owner, take such action as may be necessary to cause the suspension of any further payment, advance, or guarantee of funds. Furthermore, failure to submit the required records upon request or to make such records available may be grounds for debarment action pursuant to 29 CFR 5.12.

3.4 Apprentices and trainees

3.4.1 Apprentices. Apprentices will be permitted to work at less than the predetermined rate for the Work they performed when they are employed pursuant to and individually registered in a bona fide apprenticeship program registered with the U.S. Department of Labor, Employment and Training Administration, Office of Apprenticeship Training, Employer and Labor Services, or with a State Apprenticeship Agency recognized by the Office, or if a person is employed in his or her first ninety (90) days of probationary employment as an apprentice in an eligible apprenticeship

program, who is not individually registered in the program, but who has been certified by the Office of Apprenticeship Training, Employer and Labor Services or a State Apprenticeship Agency (where appropriate) to be eligible for probationary employment as an apprentice. The allowable ratio of apprentices to journeymen on the job Site in any craft classification shall not be greater than the ratio permitted to the Contractor as to the entire work force under the registered program. Any worker listed on a payroll at an apprentice wage rate, who is not registered or otherwise employed as stated above, shall be paid not less than the applicable wage rate on the wage determination for the classification of Work actually performed. In addition, any apprentice performing Work on the job Site in excess of the ratio permitted under the registered program shall be paid not less than the applicable wage rate on the wage determination for the Work actually performed. Where a Contractor is performing construction on a project in a locality other than that in which its program is registered, the ratios and wage rates (expressed in percentages of the journeyman's hourly rate) specified in the Contractor's or Subcontractor's registered program shall be observed. Every apprentice must be paid at not less than the rate specified in the registered program for the apprentice's level of progress, expressed as a percentage of the journeyman hourly rate specified in the applicable wage determination. Apprentices shall be paid fringe benefits in accordance with the provisions of the apprenticeship program. If the apprenticeship program does not specify fringe benefits, apprentices must be paid the full amount of fringe benefits listed on the wage determination for the applicable classification. If the Administrator determines that a different practice prevails for the applicable apprentice classification, fringes shall be paid in accordance with that determination. In the event the Office of Apprenticeship Training, Employer and Labor Services, or a State Apprenticeship Agency recognized by the Office, withdraws approval of an apprenticeship program, the Contractor will no longer be permitted to utilize apprentices at less than the applicable predetermined rate for the Work performed until an acceptable program is approved.

3.4.2 Trainees. Except as provided in 29 CFR 5.16, trainees will not be permitted to Work at less than the predetermined rate for the Work performed unless they are employed pursuant to and individually registered in a program which has received prior approval, evidenced by formal certification by the U.S. Department of Labor, Employment and Training Administration. The ratio of trainees to journeymen on the job Site shall not be greater than permitted under the plan approved by the Employment and Training Administration. Every trainee must be paid at not less than the rate specified in the approved program for the trainee's level of progress, expressed as a percentage of the journeyman hourly rate specified in the applicable wage determination. Trainees shall be paid fringe benefits in accordance with the provisions of the trainee program. If the trainee program does not mention fringe benefits, trainees shall be paid the full amount of fringe benefits listed on the wage determination unless the Administrator of the Wage and Hour Division determines that there is an apprenticeship program associated with the corresponding journeyman wage rate on the wage determination which provides for less than full fringe benefits for apprentices. Any employee listed on the payroll at a trainee rate who is not registered and participating in a training plan approved by the Employment and Training Administration shall be paid not less than the applicable wage rate on the wage determination for the classification of Work actually performed. In addition, any trainee performing Work on the job Site in excess of the ratio permitted under the registered program shall be paid not less than the

applicable wage rate on the wage determination for the Work actually performed. In the event the Employment and Training Administration withdraws approval of a training program, the Contractor will no longer be permitted to utilize trainees at less than the applicable predetermined rate for the Work performed until an acceptable program is approved.

3.4.3 Equal employment opportunity. The utilization of apprentices, trainees and journeymen under this part shall be in conformity with the equal employment opportunity requirements of Executive Order 11246, as amended, and 29 CFR part 30.

3.5 Compliance with Copeland Act requirements. Contractor shall comply with the requirements of 29 CFR part 3, which are incorporated by reference in this Contract.

3.6 Subcontracts. The Contractor or Subcontractor shall insert in any subcontracts the clauses contained in 29 CFR 5.5(a)(1) through (10) and such other clauses as the Federal agency may by appropriate instructions require, and also a clause requiring the Subcontractors to include these clauses in any lower tier subcontracts. The Contractor shall be responsible for the compliance by any Subcontractor or lower tier Subcontractor with all the Contract clauses in 29 CFR 5.5.

3.7 Contract termination: debarment. A breach of the Contract clauses in 29 CFR 5.5 may be grounds for termination of the Contract, and for debarment as a Contractor and a Subcontractor as provided in 29 CFR 5.12.

3.8 Compliance with Davis-Bacon and Related Act requirements. All rulings and interpretations of the Davis-Bacon and Related Acts contained in 29 CFR parts 1, 3, and 5 are herein incorporated by reference in this Contract.

3.9 Disputes concerning labor standards. Disputes arising out of the labor standards provisions of this Contract shall not be subject to the general disputes clause of this Contract. Such disputes shall be resolved in accordance with the procedures of the Department of Labor set forth in 29 CFR parts 5, 6, and 7. Disputes within the meaning of this clause include disputes between the Contractor (or any of its Subcontractors) and the contracting agency, the U.S. Department of Labor, or the employees or their representatives.

3.10 Certification of eligibility.

3.10.1 By entering into this Contract, the Contractor certifies that neither it (nor he or she) nor any person or firm who has an interest in the Contractor's firm is a person or firm ineligible to be awarded Government contracts by virtue of section 3(a) of the Davis-Bacon Act or 29 CFR 5.12(a)(1).

3.10.2 No part of this Contract shall be subcontracted to any person or firm ineligible for award of a Government contract by virtue of section 3(a) of the Davis-Bacon Act or 29 CFR 5.12(a)(1).

3.10.3 Contractor shall be subject to the penalty for making false statements prescribed in the U.S. Criminal Code, 18 U.S.C. 1001.

3.11 Clauses Mandated by Contract Work Hours and Safety Standards Act.

As used in the following paragraphs, the terms laborers and mechanics include watchmen and guards.

3.11.1 Overtime requirements. No Contractor or Subcontractor contracting for any part of the Contract Work which may require or involve the employment of laborers or mechanics shall require or permit any such laborer or mechanic in any workweek in which he or she is employed on such Work to work in excess of forty hours in such workweek unless such laborer or mechanic receives compensation at a rate not less than one and one-half times the basic rate of pay for all hours worked in excess of forty hours in such workweek.

3.11.2 Violation; liability for unpaid wages; liquidated damages. In the event of any violation of the clause set forth in the foregoing paragraph the Contractor and any Subcontractor responsible therefor shall be liable for the unpaid wages. In addition, such Contractor and Subcontractor shall be liable to the United States for liquidated damages. Such liquidated damages shall be computed with respect to each individual laborer or mechanic, including watchmen and guards, employed in violation of the foregoing paragraph, in the sum of \$10 for each calendar day on which such individual was required or permitted to Work in excess of the standard workweek of forty hours without payment of the overtime wages required by the foregoing paragraph.

3.11.3 Withholding for unpaid wages and liquidated damages. The District may upon its own action or upon written request of an authorized representative of the Department of Labor withhold or cause to be withheld, from any moneys payable on account of Work performed by the Contractor or Subcontractor under the Contract or any other Federal contract with the same Contractor, or any other federally-assisted contract subject to the Contract Work Hours and Safety Standards Act, which is held by the same Contractor, such sums as may be determined to be necessary to satisfy any liabilities of such Contractor or Subcontractor for unpaid wages and liquidated damages as provided in the foregoing paragraph.

3.11.4 Subcontracts. The Contractor or Subcontractor shall insert in any subcontracts the foregoing paragraphs concerning "Overtime requirements" and "Violation; liability for unpaid wages; liquidated damages" and also a clause requiring each Subcontractor to include these clauses in any lower tier subcontracts. Contractor shall be responsible for compliance by any Subcontractor or lower tier Subcontractor with the clauses set forth in paragraphs 27.11.1 through 27.11.4 of this section.

- **Preliminary Schedule of Values**

The preliminary schedule of values shall include, at a minimum, the following information and the following structure:

**Bid 654
Rio Mesa High School Well No.2
Rehabilitation
RMHS**

**OXNARD UNION HSD
DIVISION ZERO-71**

Replace Section 10.1.1.2.3 in the General Conditions with the following provisions:

10.1.1.2.3 The preliminary schedule of values shall not provide for values any greater than the following percentages of the Contract value:

10.1.1.2.3.1 Mobilization and layout combined to equal not more than [1]%;

10.1.1.2.3.2 Submittals, samples and shop drawings combined to equal not more than [3]%;

10.1.1.2.3.3 Bonds and insurance combined to equal not more than [2]%;

10.1.1.2.3.4 Closeout documentation shall have a value in the preliminary schedule of not less than [5]%;

- **COVID-19 Safety and Social Distancing Requirements**

Contractor shall, at its cost, timely comply with all applicable federal, State, and local requirements relating to COVID-19 or other public health emergency/epidemic/pandemic including, without limitation, preparing, posting, and implementing a Social Distancing Protocol, as required. In addition, Contractor's Safety Plan, required under the General Conditions, must include an Appendix labeled "COVID-19 SAFETY PLAN" (for example), which must detail Contractor's safety and compliance plan for COVID-19 or other public health emergency/epidemic/pandemic, specifically adapted from the Project including, without limitation, the following: signage, measures to protect employee health, measures to prevent crowds from gathering, measures to keep people at least six feet apart, measures to prevent unnecessary contact, and measures to increase sanitization.

END OF DOCUMENT

**HAZARDOUS MATERIALS
PROCEDURES & REQUIREMENTS**

22. Summary

This document includes information applicable to hazardous materials and hazardous waste abatement.

23. Notice of Hazardous Waste or Materials

- a. Contractor shall give notice in writing to the District, the Construction Manager, and the Architect promptly, before any of the following materials are disturbed, and in no event later than twenty-four (24) hours after first observance, of any:
 - (1) Material that Contractor believes may be a material that is hazardous waste or hazardous material, as defined in section 25117 of the Health and Safety Code, that is required to be removed to a Class I, Class II, or Class III disposal site in accordance with provisions of existing law;
 - (2) Other material that may present a substantial danger to persons or property exposed thereto in connection with Work at the site.
- b. Contractor's written notice shall indicate whether the hazardous waste or material was shown or indicated in the Contract Documents to be within the scope of Work, and whether the materials were brought to the site by Contractor, its Subcontractors, suppliers, or anyone else for whom Contractor is responsible. As used in this section the term "hazardous materials" shall include, without limitation, asbestos, lead, Polychlorinated biphenyl (PCB), petroleum and related hydrocarbons, and radioactive material.
- c. In response to Contractor's written notice, the District shall investigate the identified conditions.
- d. If the District determines that conditions do not involve hazardous materials or that no change in terms of Contract is justified, the District shall so notify Contractor in writing, stating reasons. If the District and Contractor cannot agree on whether conditions justify an adjustment in Contract Price or Contract Time, or on the extent of any adjustment, Contractor shall proceed with the Work as directed by the District.
- e. If after receipt of notice from the District, Contractor does not agree to resume Work based on a reasonable belief it is unsafe, or does not agree to resume Work under special conditions, then District may order such portion of Work that is in connection with such hazardous condition or such affected area to be deleted from the Work, or performed by others, or District may invoke its rights to terminate the Contract in whole or in part. District will determine entitlement to or the amount or extent of an adjustment, if any, in

Contract Price or Contract Time as a result of deleting such portion of Work, or performing the Work by others.

- f. If Contractor stops Work in connection with any hazardous condition and in any area affected thereby, Contractor shall immediately redeploy its workers, equipment, and materials, as necessary, to other portions of the Work to minimize delay and disruption.

24. Additional Warranties and Representations

- a. Contractor represents and warrants that it, its employees, and its subcontractors and their employees, shall at all times have the required levels of familiarity with the Site and the Work, training, and ability to comply fully with all applicable laws and contractual requirements for safe and expeditious performance of the Work, including whatever training is or may be required regarding the activities to be performed (including, but not limited to, all training required to address adequately the actual or potential dangers of Contract performance).
- b. Contractor represents and warrants that it, its employees, and its subcontractors and their employees, shall at all times have and maintain in good standing any and all certifications and licenses required by applicable federal, state, and other governmental and quasi-governmental requirements applicable to the Work.
- c. Contractor represents and warrants that it has studied carefully all requirements of the Specifications regarding procedures for demolition, hazardous waste abatement, or safety practices, specified in the Contract, and prior to submitting its bid, has either (a) verified to its satisfaction that the specified procedures are adequate and sufficient to achieve the results intended by the Contract Documents, or (b) by way of approved "or equal" request or request for clarification and written Addenda, secured changes to the specified procedures sufficient to achieve the results intended by the Contract Documents. Contractor accepts the risk that any specified procedure will result in a completed Project in full compliance with the Contract Documents.

25. Monitoring and Testing

- a. District reserves the right, in its sole discretion, to conduct air monitoring, earth monitoring, Work monitoring, and any other tests (in addition to testing required under the agreement or applicable law), to monitor Contract requirements of safe and statutorily compliant work methods and (where applicable) safe re-entry level air standards under state and federal law upon completion of the job, and compliance of the work with periodic and final inspection by public and quasi-public entities having jurisdiction.
- b. Contractor acknowledges that District has the right to perform, or cause to be performed, various activities and tests including, but not limited to, pre-abatement, during abatement, and post-abatement air monitoring, that District shall have no obligation to perform said activities and tests, and that

a portion of said activities and tests may take place prior to the completion of the Work by Contractor. In the event District elects to perform these activities and tests, Contractor shall afford District ample access to the Site and all areas of the Work as may be necessary for the performance of these activities and tests. Contractor will include the potential impact of these activities or tests by District in the Contract Price and the Scheduled Completion Date.

- c. Notwithstanding District's rights granted by this paragraph, Contractor may retain its own industrial hygiene consultant at Contractor's own expense and may collect samples and may perform tests including, but not limited to, pre-abatement, during abatement, and post-abatement personal air monitoring, and District reserves the right to request documentation of all such activities and tests performed by Contractor relating to the Work and Contractor shall immediately provide that documentation upon request.

26. Compliance with Laws

- a. Contractor shall perform safe, expeditious, and orderly work in accordance with the best practices and the highest standards in the hazardous waste abatement, removal, and disposal industry, the applicable law, and the Contract Documents, including, but not limited to, all responsibilities relating to the preparation and return of waste shipment records, all requirements of the law, delivering of all requisite notices, and obtaining all necessary governmental and quasi-governmental approvals.
- b. Contractor represents that it is familiar with and shall comply with all laws applicable to the Work or completed Work including, but not limited to, all federal, state, and local laws, statutes, standards, rules, regulations, and ordinances applicable to the Work relating to:
 - (1) The protection of the public health, welfare and environment;
 - (2) Storage, handling, or use of asbestos, PCB, lead, petroleum based products, radioactive material, or other hazardous materials;
 - (3) The generation, processing, treatment, storage, transport, disposal, destruction, or other management of asbestos, PCB, lead, petroleum, radioactive material, or hazardous waste materials or other waste materials of any kind; and
 - (4) The protection of environmentally sensitive areas such as wetlands and coastal areas.

27. Disposal

- a. Contractor has the sole responsibility for determining current waste storage, handling, transportation, and disposal regulations for the job Site and for each waste disposal facility. Contractor must comply fully at its sole cost and expense with these regulations and any applicable law. District may, but is

not obligated to, require submittals with this information for it to review consistent with the Contract Documents.

- b. Contractor shall develop and implement a system acceptable to District to track hazardous waste from the Site to disposal, including appropriate "Hazardous Waste Manifests" on the EPA form, so that District may track the volume of waste it put in each landfill and receive from each landfill a certificate of receipt.
- c. Contractor shall provide District with the name and address of each waste disposal facility prior to any disposal, and District shall have the express right to reject any proposed disposal facility. Contractor shall not use any disposal facility to which District has objected. Contractor shall document actual disposal or destruction of waste at a designated facility by completing a disposal certificate or certificate of destruction forwarding the original to the District.

28. Permits

- a. Before performing any of the Work, and at such other times as may be required by applicable law, Contractor shall deliver all requisite notices and obtain the approval of all governmental and quasi-governmental authorities having jurisdiction over the Work. Contractor shall submit evidence satisfactory to District that it and any disposal facility:
 - (1) have obtained all required permits, approvals, and the like in a timely manner both prior to commencement of the Work and thereafter as and when required by applicable law; and
 - (2) are in compliance with all such permits, approvals and the regulations.

For example, before commencing any work in connection with the Work involving asbestos-containing materials, or PCBs, or other hazardous materials subject to regulation, Contractor agrees to provide the required notice of intent to renovate or demolish to the appropriate state or federal agency having jurisdiction, by certified mail, return receipt requested, or by some other method of transmittal for which a return receipt is obtained, and to send a copy of that notice to District. Contractor shall not conduct any Work involving asbestos-containing materials or PCBs unless Contractor has first confirmed that the appropriate agency having jurisdiction is in receipt of the required notification. All permits, licenses, and bonds that are required by governmental or quasi-governmental authorities, and all fees, deposits, tap fees, offsite easements, and asbestos and PCB disposal facilities expenses necessary for the prosecution of the Work, shall be procured and paid for by Contractor. Contractor shall give all notices and comply with the all applicable laws bearing on the conduct of the Work as drawn and specified. If Contractor observes or reasonably should have observed that Plans and Specifications and other Contract Documents are at variance therewith, it shall be responsible for promptly notifying District in writing of such fact. If

Contractor performs any Work contrary to applicable laws, it shall bear all costs arising therefrom.

- b. In the case of any permits or notices held in District's name or of necessity to be made in District's name, District shall cooperate with Contractor in securing the permit or giving the notice, but the Contractor shall prepare for District review and execution upon approval, all necessary applications, notices, and other materials.

29. Indemnification

To the fullest extent permitted by law, the indemnities and limitations of liability expressed throughout the Contract Documents apply with equal force and effect to any claims or liabilities imposed or existing by virtue of the removal, abatement, and disposal of hazardous waste. This includes, but is not limited to, liabilities connected to the selection and use of a waste disposal facility, a waste transporter, personal injury, property damage, loss of use of property, damage to the environment or natural resources, or "disposal" and "release" of materials associated with the Work (as defined in 42 U.S.C. § 9601 *et seq.*).

30. Termination

District shall have an absolute right to terminate for default immediately without notice and without an opportunity to cure should Contractor knowingly or recklessly commit a material breach of the terms of the Contract Documents, or any applicable law, on any matter involving the exposure of persons or property to hazardous waste. However, if the breach of contract exposing persons or property to hazardous waste is due solely to an ordinary, unintentional, and non-reckless failure to exercise reasonable care, then the procedures for termination for cause shall apply without modification.

END OF DOCUMENT



CONTRACTORS
STATE LICENSE BOARD
ACTIVE LICENSE



License Number: **496765**

Entity: CORP

Business Name: GENERAL PUMP COMPANY INC

Classification: C57 C61/D21 A

Expiration Date: 08/31/2022

www.cslb.ca.gov





APPLICATION FOR PUBLIC WORKS CONTRACTOR REGISTRATION

Registration Information

Type: Renewal

Period: July 1, 2019 – June 30, 2022

Contractor Information

Contractor Name: GENERAL PUMP COMPANY, INC.

Trade Name:

License Type Number: 1000002769

Contractor Physical Address

Physical Business Country: United States of America

Physical Business Address: 159 N. ACACIA ST.

Physical Business City/ Province: SAN DIMAS

Physical Business State: CA

Physical Business Postal Code: 91773

Contractor Mailing Address

Mailing Business Country:

Mailing Business Address:

Mailing Business City/ Province:

Mailing Business State:

Mailing Business Postal Code:

Contact Info

Daytime Phone:

Mobile Phone:

Daytime Phone Ext.:

Business Email: gcampbell@genpump.com

Applicant's Email: asantacruz@genpump.com

Workers' Compensation

Professional Employer Organization (PEO)

Do you lease employees through Professional Employer Organization? No

Workers' Compensation Overview

Insured by carrier

Carrier: TRAVELERS PROPERTY
CASUALTY INSURANCE
COMPANY

Inception Date: June 1, 2017

Policyholder Name: GENERAL PUMP COMPANY,
INC.

Expiration Date: May 30, 2018

Policy Number: PJUB-5946N79-9-16

Certification

- Yes I certify that I do not have any delinquent liability to an employee or the state for any assessment of back wages or related damages, interest, fines, or penalties pursuant to any final judgment, order, or determination by a court or any federal, state, or local administrative agency, including a confirmed arbitration award
- Yes I certify that the contractor is not currently debarred under Section 1777.1 or under any other federal or state law providing for the debarment of contractors from public works.
- Yes I certify that one of the following is true: (1) I am licensed by the Contractors State License Board (CSLB) in accordance with Chapter 9 (commencing with Section 7000) of the Business and Professions Code; or (2) my business or trade is not subject to licensing by the CSLB.

I understand refunds are not authorized

I, Allison Santa Cruz, the undersigned, am , GENERAL PUMP COMPANY, INC. with the authority to act for and on behalf of the above named contractor. I certify under penalty of perjury that all of the above information provided is true and correct. I further acknowledge that any untruthful information provided in this application could result in the certification being canceled.

I certify this on: 5/24/2019 8:51:18 AM

Legal Entity Information

Legal Entity Type: Corporation

Name: GENERAL PUMP COMPANY, INC.



KEY PERSONNEL

KEY PERSONNEL

MICHAEL G. BODART, PRESIDENT / DIRECTOR OF ENGINEERING

Academic Background University of Missouri - Bachelor of Science in Civil Engineering
Post Graduate C.E. Courses in Geohydrology, University of Southern California

Certifications 1999-Byron Jackson Training Certificate
1998-Grade 1 & 2 Distribution and Treatment Certificates
1998-Engineering "A" License
1995-Dale Carnegie Course
1995-Mackay Pump Rehabilitation Certificate
1992-Golden State Pump Technical Training Certificate
1990-Completed Graduate C.E. Courses in Geohydrology at U.S.C.
1986-Layne & Bowler Pump School Certification
1986-Baroid 1-week Drilling Fluid Technology Course Certification
1985-National Water Works Correspondence Course Certification

Professional Present Experience General Pump Company, Inc. - President / Director of Engineering - 1993-
Layne Western - Regional Engineering and Sales Manager (4 offices)
Federal Highway Administration - Civil Engineer

Professional Presentations Michael G. Bodart (Mike Bodart) is recognized as an expert in the field of pump engineering and well rehabilitation in southern California. He has been invited to speak for numerous professional water related associations and conventions. Has been speaking professionally for more than 34 years and has presented in nationally known associations such as AWWA, Tri-State, Southern California Water Utility Association, Inland Water Works Association, Groundwater Resources Association and Central Coast Water Association. In 1992, Mike was part of a selected six-person panel of engineers who met in Kansas City to assist in training nationwide engineers in the water well pump business.

THOMAS A. NANCHY, SR. PROJECT MANAGER / PROJECT ENGINEER

2004-Byron Jackson Training Certificate
1989-Dale Carnegie Course
1992-Golden State Pump Technical Training Certificate
1986-Layne & Bowler Pump School Certification
1994-Baroid 1-week Drilling Fluid Technology Course Certification
1998-National Water Works Correspondence Course Certification
1994-Goulds Pump Course
2020-BNSF Safety Course

Professional Experience Tom Nanchy, Sr. Project Manager, has been in the well and pump industry for over Forty (40) years. Throughout his professional career, he has been involved with hundreds of well rehabilitations and is highly regarded in the industry. His wide range of experience allows him to solve many difficult well and pump



issues and provide options. He has also spoken at many professional organizations throughout California with regards to well maintenance and well rehabilitations. Tom is AWWA certified pump installer and a certified pump installer for Large Water Systems (NGWA). He is factory trained and certified by Byron Jackson and Cla-Valve. Tom also holds a certificate with the Mine Safety and Health Administration (MSHA).

WALTER "RAY" REECE JR. BSBM-BSBA, GENERAL MANAGER

**Professional
Experience**

Combined over 40 years of experience managing businesses providing well rehabilitation, maintenance, well drilling, coring, pump manufacturing, and investigative drilling in the environmental, mining, energy and water resource industries. Earned two Bachelor of Science degrees in Business Administration and Management including a Finance focus. Identified, developed and negotiated contracts with private, public and governmental agencies to safely and successfully provide well rehabilitation technologies, pump and motor maintenance, drilling and construction services for a variety of applications. Ray has devoted time to technological transfers of information by conducting industry related seminars and guest lecturing at High Schools, Colleges, Universities, SME, AWWA, and the California Nevada American Water Works Association (Cal-NV AWWA).

FERNANDO MUNOZ. OPERATIONS MANAGER

**Professional
Experience**

Over 40 years' experience of quality control to ensure pumps are ready for installation, scheduling and management of shop and field production crews, and day-to-day management of those Company areas.

Certifications Grade 2 - Distribution Certificate
Grade 2 - Water Treatment Operator

JAMES M. HINSON, SR. APPLICATION ENGINEER

**Professional
Experience**

Over 40 years' experience of pump engineering. Conducts systems analyses, defines new and/or replacement hydraulic requirements, designs to procurement of materials.

LUIS A. BUSSO, P.G., SR. PROJECT GEOLOGIST

**Professional
Experience**

Professional groundwater work for the past 14 years encompassing field monitoring and technical report writing for siting, geologic log analysis, design, construction, pump testing, water quality sampling, and rehabilitation of municipal-supply and irrigation-supply water wells. Combining geological and industry knowledge toward well project developments on behalf of water districts, cities, farmers, and other private owners within Central and Southern



California. He currently works alongside Ray Reece, at General Pump Company's Camarillo facility to design and implement pump and well solutions for the clients in the greater Santa Barbara and Ventura Counties.

Academic

Background University of California Santa Barbara – Bachelor of Science in Geologic Studies

MARK HAAS, PROJECT MANAGER

Professional

Background Professional background includes 18 years' experience within the well and pump industry. His experience includes Field Service Technician, AirBurst® Operations to include R & D for Frazier Industries and Bolt, Technologies for air gun operations and functionality and Certified Crane Operator.

MICHAEL R. GARCIA, PROJECT ENGINEER

Professional

Background Work alongside Project Manager to ensure progression and completion of pump projects. Review project specifications and prepare documents for engineered projects including as-built drawings and field crew instructions. Assist in project coordination and communication between field crews, vendors, and customers.

Academic

Background Loyola Marymount University, Los Angeles-Master of Science in Mechanical Engr.
University of Redlands, Redlands - Bachelor of Science in Physics

DANIEL J. PICHARDO, PROJECT ENGINEER

Professional

Background Coordinate with project managers, operations manager, and senior applications engineer for materials procurement for all existing projects. Communicate with vendors and customers for timely delivery. Maintain safety manuals for continued safety compliance.

Academic

Background Seattle University - Bachelor of Science, Civil Engineering, Mathematics Minor

J. ALFREDO ("FREDDY") RAMIREZ, PROJECT MANAGER

Professional

Background Professional background includes 23 years' experience within the well and pump industry. His experience includes designing complete pump assemblies, performing well rehabs, well destructions as well as welding. His wide range of experience allows him to have knowledge in multiple fields in the industry.



QUALIFICATIONS, EXPERIENCE, AND UNDERSTANDING OF THE PROJECT

CAPABILITIES

General Pump Company, Inc. is a Professional Well Redevelopment and Pump Equipment contractor located in San Dimas and Camarillo, California. The Engineering staff, field support and service crews, and office support staff are 100% dedicated to well evaluation and rehabilitation, and pump equipment evaluation and services.

The technical staff at General Pump Company, Inc. has worked in almost every aspect of the well and pump industries. This diverse experience provided us with unique qualifications to serve our customers and provide them with solution-oriented approaches to get their system back into operation. Our engineers and Hydrogeologist have all worked in the drilling and design segment of the water, and/or oil and gas industries, and many of our shop and support technicians have worked for major pump manufactures.

General Pump Company, Inc. employs only experienced Engineers, Hydrogeologist and Technical Field Personnel that can offer Customers assistance in the following areas:

- Assess Well Yields to Minimize Operating and Maintenance Costs
- Determine the Efficiency of Production and ASR Wells and Pumps
- Engineered Pump and Well Equipment
- Pump Facility Design and Construction / Booster Facility Design and Construction
- Pipeline Design and Construction
- Appropriate Mechanical and Chemical Redevelopment
- Periodic Monitor and Maintenance Programs
- Water Quality and Production Solutions / Well System Optimization
- Engineered Pump Suctions
- Pump and Motor Repair / Custom Pump Design and Machining
- Electrical, SCADA and Transducer Support
- Casing Repair and Swedging
- Video and Geophysical Logging Support

General Pump Company, Inc., an Engineering Service Company, is dedicated to supporting the ongoing needs of the Water Industry, and committed to providing:

- Solution-oriented engineering using problem-solving techniques by degreed Engineers with diverse well system and groundwater experience, and pump application engineers from major pump manufacturing companies.
- Full-time machine shop, staffed with experienced personnel capable of building and repairing standard and custom pump equipment and specialty products.
- Self-contained chemical trailers to include safety support and operational controls.
- Trained and certified operators for periodic monitoring and maintenance programs.
- In-house training facility and training programs for customers and our own personnel.
- Strong project and construction management for any size project.
- Instant communications with cellular radio/phones for all staff, engineering, technical, field and shop personnel, resulting in better services at a reduced risk and overall cost.
- Modern, safe and reliable equipment with the **Only Telescoping Well Rigs with Spudders** in the industry which are required for effective redevelopment of wells in pump houses.



SAFETY

Safety is paramount when men and equipment are involved. A good safety record is important along with adequate insurance and bonding. General Pump Company, Inc. has the best safety record in Southern California for the water well and pump rehabilitation business. Over the past years, General Pump Company, Inc. has had minimal loss of time for work related injuries

ANNUAL CONTRACTS

Award of an Annual Contract is a great honor and to have an Annual Contract renewed year after year is the greatest complement to a service company. It proves that the contractor has met or exceeded the customers' set goals and expectations. General Pump Company, Inc. has been selected by over 45 cities in Southern California to maintain their well and pumping systems. We have more Annual Contracts with cities than all our competitors combined. Additionally, General Pump Company, Inc. is the primary contractor or sole-source contractor for 15 private utilities and water districts. Most of these are multi-year contracts having been renewed several times over.

MACHINE SHOP CAPABILITIES

General Pump Company, Inc. is the only well and pump Service Company in Southern California that builds 100% of our bowl assemblies. This level of expertise, along with our in-house machining, allows us to supply or repair with a greater level of knowledge that your pump equipment will be reliable and efficient.

Our repair and fabrication facility maintains the most complete line of lathes, welding and associated machining tools.

General Pump Company, Inc. has an expansive repair and fabrication facility. This facility has proven to be invaluable during our 69 years of business, since many pump and motor repairs require a strong interface between machining, welding and electrical support in order to be completed. We have three major groups within our repair and fabrication facility that allow us to serve your needs in a variety of ways:

- **Fabrication and Machining:** Including lathes, milling machines, grinders, balancing machines, flame welding, gas and electric welding, heli-arc, etc. We perform welding on steel, aluminum, brass, cast iron, resurfacing, and custom work.

We repair all types of pumps by all manufacturers in our facility up to approximately 24-inch impeller diameter for single and multi-stage Horizontal Pumps and 30-inch diameter for Vertical Turbine Pumps.

- **Assembly:** In general, the pumps we supply are designed and manufactured by General Pump Company at one of our Engineering Service Centers. Assembly of pumps assures the highest quality product, with the assurance that it is built correctly and will meet the design criteria specified.
- **Field Services:** This service has helped us establish ourselves as well and pump problem solvers since many operational problems can be traced to poor installation practices. Having the proper diagnostic equipment and knowing how to use it distinguishes us as "The Leader in Well and Pump Services".



MACHINE SHOP CAPABILITIES *(Continued)*

Precision Alignment - We've invested in the latest Precision Alignment technology and have established a growing list of customers who use us for these services.

Removal, Installation, Mechanical and Startup - We perform field-testing, removal, installation and machining services to offer a turnkey pump service.

General Pump Company, Inc. can provide you with high quality workmanship to meet your water supply needs. Our highly skilled employees can also perform repairs on many types of well and booster pumps.

Pump Repair

Booster
End Suction
Horizontal Split Case
Vertical Turbine
Right-Angle Drive

Machine Shop

Shaft Manufactured:

Pumps & Motors, Precision
Straightening, Electrical Motors

Sleeves Made:

Bronze, Mild Steel, Stainless
Steel

Threads and Tapping

Impeller Rebuilding

Balancing, Trimmed
Eyes & Flanges

Mechanical Seals

Re-Machine Seat, High
Pressure, High
High Temperature

Electric Motors

New & Overhauled, Rewound,
Balanced, Custom Bases,
Shaft Repaired Upgrades

EQUIPMENT AND FIELD SERVICE

General Pump Company, Inc. maintains a full service machine shop, clean and safe rigs and cranes are a minimum requirement for reliability, quality workmanship and safety.

General Pump Company, Inc. has several trucks fully loaded with essential equipment to handle many urgent repairs in the field. Our well and pump service crews are always ready and willing to assist your Water Utility with making a repair to keep your well and booster facilities running. Just let us know and we will be on the way, ready to provide you with the highest quality service available.

General Pump Company, Inc. has the newest fleet of rigs and equipment in Southern California. Maintenance and repairs are made at our San Dimas and Camarillo Facilities to make sure our field operations can safely and efficiently respond to our customer's needs. Below are the benefits to our customers.

- Reliable work - In water emergencies, it is important that this large equipment is ready to respond without breakdowns.
- Safety - Our new equipment is not likely to malfunction resulting in major damage or possible injuries.
- The most up-to-date equipment to assemble the Customers' pumps.

General Pump Company, Inc. has the only telescoping pump rigs in Southern California.



General Pump Company, Inc. has chemical treatment equipment with fully operational safety equipment that includes eyewash and shower, along with other special redevelopment tools, which allow General Pump Company, Inc. to perform the most cost-effective cleaning to your wells.

-oOo-